



Manufacturer's Representative for the HVAC Industry Since 1977

STOCK CATALOG

Access Doors

Accessories

Actuators

Backdraft Dampers

Control Dampers

Diffusers/Screens

Duct Silencers

Fans

Fire/Smoke Dampers

Louvers

Registers/Grilles

Smoke Detectors

Terminal Units

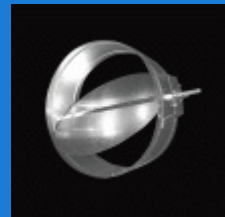
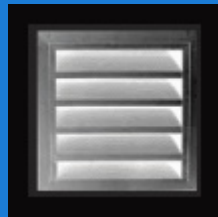
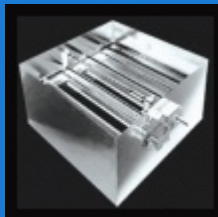
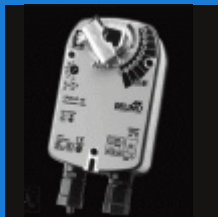
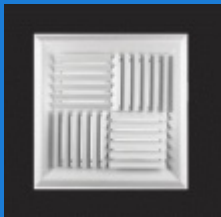

PRODUCT LINES

- Access Doors & Panels
- Air Control Dampers
- Air Doors
- Air Distribution
- Architectural Louvers & Penthouses
- Architectural Screens & Grilles
- Backdraft Dampers
- Fans & Blowers
- Roof/Smoke Hatches
- Electric Duct Heaters
- Fire & Smoke Dampers
- Gravity Ventilators
- Kitchen Exhaust Systems
- Motors
- Controls & Damper Accessories
- Sound Attenuators & Enclosures
- VAV Terminal Units
- Security Grilles & Bars

MANUFACTURES



TABLE OF CONTENTS

Dampers

| | |
|--------------------------------|---|
| Fire/Smoke Dampers..... | 1 |
| Vertical Curtain Dampers..... | 2 |
| Square to Round Adaptors..... | 2 |
| Ceiling Radiation Dampers..... | 3 |
| Mounting Angles..... | 3 |
| Air Control Dampers..... | 4 |
| Backdraft Dampers..... | 5 |
| Damper Accessories..... | 6 |

Actuators & Accessories

| | |
|-------------------------|-----|
| U.L. Actuators..... | 7-9 |
| Pneumatic Actuator..... | 7-9 |
| Smoke Detectors..... | 10 |

Access Doors & Roof Hatches

| | |
|---------------------------------|-------|
| Exterior Access Panel..... | 11 |
| Stock Drywall Access Doors..... | 12 |
| Duct Access Doors..... | 13-15 |

Terminal Units

| | |
|---------------------------------|-------|
| Single Duct Terminal Units..... | 16-17 |
| VAV Accessories..... | 18 |

Air Distribution

| | |
|----------------------------------|-------|
| Linear Slot Diffusers..... | 19 |
| Insulated Diffuser Plenum..... | 19 |
| Perforated Lay-In Diffusers..... | 20-22 |

Air Distribution (cont.)

| | |
|--|----|
| Perforated Lay-In Screens..... | 22 |
| Perforated Surface Mount..... | 23 |
| Modular Core Diffusers..... | 24 |
| Architectural Ceiling Diffuser Lay-In..... | 24 |
| Louvered Face Ceiling Diffuser..... | 25 |
| Curved Blade Ceiling Diffuser..... | 25 |
| Thermally Powered VAV Diffuser..... | 25 |
| Round Neck Louver Diffuser Lay-In..... | 26 |
| Round Face Fixed Cone Diffuser..... | 26 |
| Fixed Bar Return Grille..... | 27 |
| Bar Style Filter Grille..... | 27 |
| Double Deflection Registers..... | 28 |
| Steel Auxiliary Frame..... | 28 |
| Aluminum Egg-Crate Grilles..... | 29 |
| Single Deflection Registers..... | 29 |
| Louvers..... | 30 |

Diffuser Accessories

| | |
|--------------------------------------|----|
| Round Opposed Blade Damper..... | 31 |
| Square Opposed Blade Damper..... | 31 |
| Round Neck Opposed Blade Damper..... | 31 |

FIRE/SMOKE DAMPERS - 5 YEAR WARRANTY

One Product - Multiple Applications

- Vertical walls.
- UL 555 & 555S class II leakage rated.
- 16" inch long, 20 gauge galvanized sleeve.
- 1-1/2" hour (vertical & horizontal).
- UL file #R11767.
- C.S.F.M file #3225-0368:110 fire rated, 3230-0368:111 leakage rated.
- Optional SSPF single sided retaining angle or loose flange (for use with air distribution).
- All units available with optional round collars shipped loose.
- All dampers supplied with Belimo 120 VAC (24 VAC available) actuators.



FSD-172 - Wall Application

- 1 hour rating for tunnel type corridor ceiling construction.
- UL 555 & 555S class II leakage rated.
- 16" inch long, 20 gauge galvanized sleeve.
- UL file #R11767.
- C.S.F.M. file #3225-0368:110 fire rating, 3230-0368:111 leakage rating.
- Optional SSPF single sided retaining angle or loose flange (for use with air distribution).
- All units available with optional round collars shipped loose.
- All dampers supplied with Belimo 120 VAC (24 VAC available actuators).
- See optional available accessories.



FSD-172 - Corridor Ceiling Application

Accessory Reference

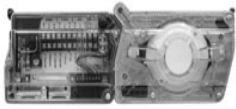

Smoke Detector - pg. 12



Actuators - pg. 9-10



Access Doors - pg. 13-17



SSPF Angles - pg. 5

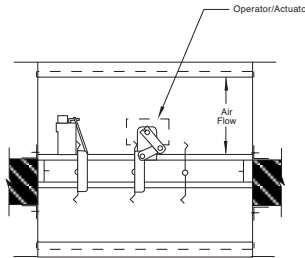

Horizontal Mount

The Model FSD-172 is cross listed for installation in one and two hour rated walls for vertical mounting. It is also listed for installations in one hour rated tunnel corridor ceilings.

| Size | Stock# |
|---------|---------|
| 6"x6" | W-11694 |
| 8"x8" | W-11695 |
| 10"x10" | W-11696 |
| 12"x12" | W-11697 |
| 14"x14" | W-11698 |
| 16"x16" | W-11699 |
| 18"x18" | W-11700 |
| 20"x20" | W-11701 |
| 22"x22" | W-11702 |
| 24"x24" | W-11703 |

Single Mounting Angle Over Drywall

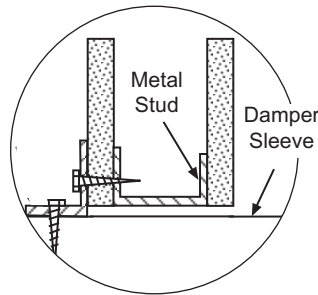

Single Mounting Angle UNDER Drywall * Metal Stud Only

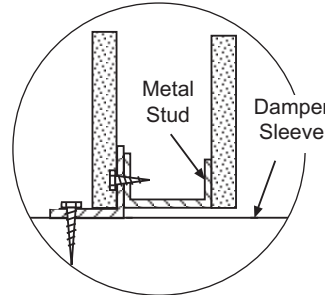

Mounting Angles

SSPF Mounting Angles

The exclusive single-side mounting angle design only requires angles on one side of partition. The ingenious corner design allows this mounting system to install either underneath or on top of the drywall offering additional installation options and cost savings. Tested and approved in accordance with U.L. standard 555 this unique system is in full compliance with all building codes for wood stud, metal stud or masonry installations.

VERTICAL FIRE DAMPERS - 5 YEAR WARRANTY



VFD-10D-A

- "A" style dynamic dampers stocked.
- Wall style vertical mount for 1 or 2 hour walls.
- 12", 20 gauge galvanized integral steel sleeve.
- U.L. file #R11767.
- C.S.F.M. file #3225-0368:101.
- Optional SSPF picture frame angles.
- Optional round collar(s) shipped loose.
- Optional loose flange for use with air distribution.

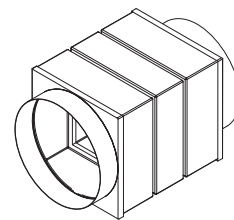

Vertical Mount
(Model - VFD-10D-ISAR shown above.
Optional round duct connection is a U.L.
approved breakaway connection.)

| Size | Stock# |
|-----------|---------|
| 6" x 6" | W-11617 |
| 8" x 8" | W-11618 |
| 10" x 10" | W-11619 |
| 12" x 12" | W-11620 |
| 14" x 14" | W-11621 |
| 16" x 16" | W-11622 |
| 18" x 18" | W-11623 |
| 20" x 20" | W-11624 |
| 22" x 22" | W-11625 |
| 24" x 24" | W-11626 |

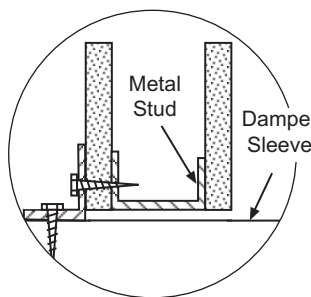

Single Mounting Angle
Over Drywall

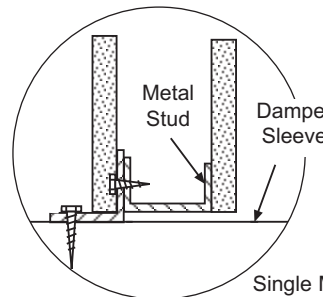

Single Mounting Angle
UNDER Drywall
* Metal Stud Only

Mounting Angles



FIRE/SMOKE DAMPERS AND FIRE DAMPERS SQUARE-TO-ROUND ADAPTORS



- The Fire/Smoke Dampers and Fire Dampers Square-to-Round Caps will not fit on the Ceiling Radiation Dampers.

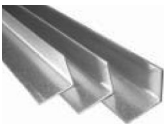

| Size | Stock# |
|-------------|---------|
| 6"x6"x6" | W-11637 |
| 8"x8"x6" | W-11638 |
| 8"x8"x8" | W-11639 |
| 10"x10"x8" | W-11640 |
| 10"x10"x10" | W-11641 |
| 12"x12"x10" | W-11642 |
| 12"x12"x12" | W-11643 |
| 14"x14"x12" | W-11644 |
| 14"x14"x14" | W-11645 |
| 16"x16"x14" | W-11646 |
| 16"x16"x16" | W-11647 |
| 18"x18"x16" | W-11648 |
| 18"x18"x18" | W-11649 |
| 20"x20"x18" | W-11650 |
| 20"x20"x20" | W-11651 |
| 22"x22"x20" | W-11652 |
| 22"x22"x22" | W-11653 |
| 24"x24"x22" | W-11654 |
| 24"x24"x24" | W-11655 |

| Accessory Reference | | |
|---|---|---|
|  |  |  |
| SSPF Angle - pg. 5 | Access Doors - pg. 13-17 | Warnock Hersey Angle Set - pg.5 |

CEILING RADIATION DAMPERS - 5 YEAR WARRANTY

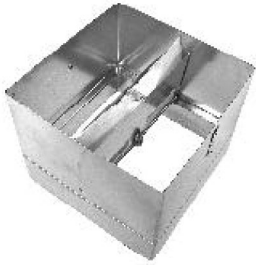

CFD-15-ES

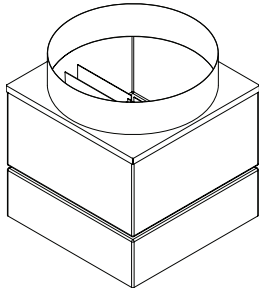

Optional round duct transition on top

Ceiling radiation dampers are for use in floor-ceiling and roof-ceiling assemblies. They are constructed of 22 gauge galvanized steel and are stocked with an extended sleeve.

- UL Listing: R14603
- CSFM Listing: 3226-0368:104
- U.L. file no. 3225-368:104.
- CRB-24 24" x 24" radiation blankets for use with T-bar ceiling diffusers.
- Stocked NET ID only
- Warnock Hersey listing: WH1-495-PSH0177,-0178
- Meets NFPA Standards: 90A & 101
- Meets building code standards: IBC, NBC, NFPA, SBC & UBC

| Size | Stock# |
|---------|---------|
| 6"x6" | W-11742 |
| 8"x8" | W-11743 |
| 10"x10" | W-11744 |
| 12"x12" | W-11745 |
| 14"x14" | W-11746 |
| 16"x16" | W-11747 |
| 18"x18" | W-11748 |
| 20"x20" | W-11749 |
| 22"x22" | W-11750 |
| 24"x24" | W-11751 |
| CRB-24 | W-11731 |



WARNOCK HERSEY MOUNTING ANGLES, FOR CFD'S ONLY

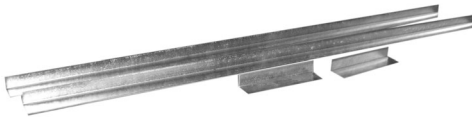

| Cat# | Size |
|---------|---|
| W-12446 | 2 pcs-1"x1/2"x28" Long x 20 ga. 2 pcs-1"x1/2"x3" Long x 20 ga. |

LOOSE FLANGE STOCK - For FSD's, VFD's AND CFDs

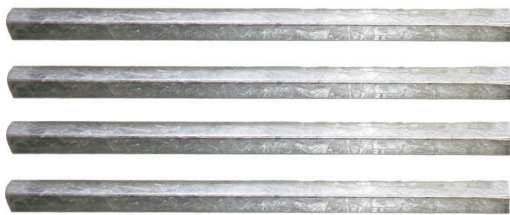

| Cat# | Size |
|---------|---------|
| W-12678 | 6"x6" |
| W-12679 | 8"x8" |
| W-12680 | 10"x10" |
| W-12681 | 12"x12" |
| W-12682 | 14"x14" |
| W-12683 | 16"x16" |
| W-12684 | 18"x18" |
| W-12685 | 20"x20" |
| W-12686 | 22"x22" |
| W-12687 | 24"x24" |

SSPF MOUNTING ANGLES - For VFD's and FSD's Only.



| Cat# | Size |
|---------|---------|
| W-11786 | 6"x6" |
| W-11787 | 8"x8" |
| W-11788 | 10"x10" |
| W-11789 | 12"x12" |
| W-11790 | 14"x14" |
| W-11791 | 16"x16" |
| W-11792 | 18"x18" |
| W-11793 | 20"x20" |
| W-11794 | 22"x22" |
| W-11795 | 24"x24" |

CONTROL DAMPERS - 5 YEAR WARRANTY



CD-42

- Single and opposed blade action available.
- 6" x 16 gauge galvanized steel blades.
- 1/2" dia. hex plated steel blade shafts.
- In-jamb linkage.
- Standard nylon bushings.
- 1/2" round x 6" drive axle with bearing.
- Dampers supplied 1/4" undersized.
- Optional electric and pneumatic actuators in stock (see accessory reference.)
- Optional manual locking quadrant (see accessory reference.)

| Size | Stock# |
|-----------|---------|
| 6" x 6" | W-11917 |
| 8" x 8" | W-11918 |
| 10" x 10" | W-11919 |
| 12" x 12" | W-11920 |
| 14" x 14" | W-11921 |
| 16" x 16" | W-11922 |
| 18" x 18" | W-11923 |
| 20" x 20" | W-11924 |
| 22" x 22" | W-11925 |
| 24" x 24" | W-11926 |



CD-10R

- 6" x 22 gauge sleeve and blade.
- Double beaded for strength.
- Easy duct connection.
- 22 gauge galvanized blade with center "V".
- 3/8" square zinc plated shafts with tight sealing nylon bushings.
- Manual locking quadrant standard with 1-1/2" stand-off bracket.
- No rattles.

| Size | Stock# |
|------|---------|
| 6" | W-11879 |
| 7" | W-12392 |
| 8" | W-11880 |
| 9" | W-12393 |
| 10" | W-11881 |
| 12" | W-11882 |
| 14" | W-11883 |
| 16" | W-11884 |
| 18" | W-11885 |
| 20" | W-11886 |
| 22" | W-11887 |
| 24" | W-11888 |



CD-25R

- 12" x 20" gauge galvanized steel sleeve.
- Double beaded for strength and easy duct connection.
- Double membrane steel blade (14 ga. equivalent).
- Polyethylene blade gasket provides full diameter seal.
- 1/2" round diameter steel blade shafts.
- Leakage less than 1% at 2" of static pressure.
- Maintains seal at 4" of static pressure.
- Optional electric and pneumatic actuators in stock.
- Optional manual locking quadrant (see accessory reference.)

| Size | Stock# |
|------|---------|
| 6" | W-11889 |
| 8" | W-11890 |
| 10" | W-11891 |
| 12" | W-11892 |
| 14" | W-11893 |
| 16" | W-11894 |
| 18" | W-11895 |
| 20" | W-11896 |
| 22" | W-11897 |
| 24" | W-11898 |

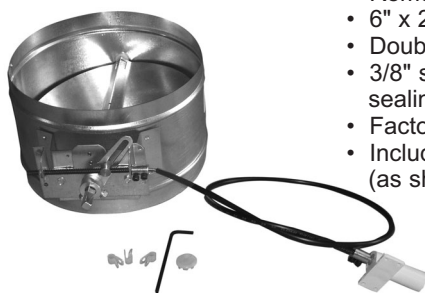

RCS-10R

- Remote controlled cable operated balancing damper.
- 6" x 22 gauge galvanized steel blade and sleeve.
- Double beaded for strength.
- 3/8" square zinc plated steel blade shafts with tight sealing nylon bushings.
- Factory assembled (no field assembly required.)
- Includes 36" cable and remote operator (as shown) (longer lengths available.)

| Size | Stock# |
|----------------|---------|
| 6" | W-12380 |
| 7" | W-12381 |
| 8" | W-12382 |
| 9" | W-12383 |
| 10" | W-12384 |
| 12" | W-12385 |
| 14" | W-12386 |
| 16" | W-12387 |
| 18" | W-12388 |
| 20" | W-12389 |
| 22" | W-12390 |
| 24" | W-12391 |
| Field Mt. Kit | W-12395 |
| Extra Cable | W-12377 |
| Ex. Insulation | W-12378 |

* Included with W-12377

Accessory Reference



Damper Accessories - pg. 8



Actuators - pg. 9-10

RCS-10R FIELD MOUNTING KIT



RCS-10R Field Mounting Kit

- Control arm/screw assembly - mounted on standoff bracket.
- Standard 36" long cable included (optional cable lengths available.)
- Allen key remote control assembly can be provided loose for use with almost any balancing damper.
- Standard 15/16" O.D. provides unobtrusive opening in ceiling or wall for architectural requirements.

BACKDRAFT DAMPERS



BD-130

5 YEAR WARRANTY

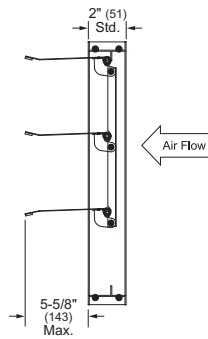

Vertical Mount

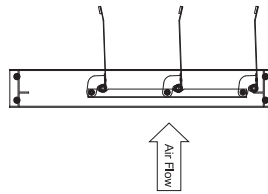

Horizontal Mount

| Size | Stock# |
|---------|---------|
| 6"x6" | W-11899 |
| 8"x8" | W-11900 |
| 10"x10" | W-11901 |
| 12"x12" | W-11902 |
| 14"x14" | W-11903 |
| 16"x16" | W-11904 |
| 18"x18" | W-11905 |
| 20"x20" | W-11906 |
| 22"x22" | W-11907 |
| 24"x24" | W-11908 |

The BD-130 is constructed with 1-7/8" x 13/16" x 0.081" extruded aluminum channel frame and 0.05" thick aluminum extruded blades. They feature synthetic bearings and blade axes. They are constructed for vertical mounting and horizontal upflow.

- Aluminum tie bar interconnects all blades for increased stability at higher velocities up to 1500 fpm
- Blade edge extruded vinyl seals reduce leakage and noise
- Units supplied approximately 1/4" under nominal duct dimension



BDR

The BDR is constructed with 20 gauge steel frame and sleeve with aluminum spring loaded blades. They are constructed for vertical mounting and horizontal upflow.

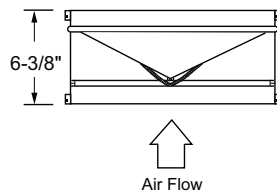

Air Flow

| Size | Stock# |
|------|---------|
| 4" | W-11909 |
| 6" | W-11911 |
| 7" | W-11912 |
| 8" | W-11913 |
| 10" | W-11914 |
| 12" | W-11915 |
| 14" | W-11916 |
| 16" | W-12281 |

- Neoprene closed cell gaskets around frame.
- Designed for low air flow gravity and fan usage less than 600 FPM.

DAMPER ACCESSORIES

U.L. DAMPER ACCESSORIES

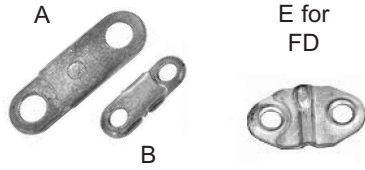

FUSIBLE

| Size | Stock# |
|----------------------|---------|
| A Style, 165 Degree | W-12099 |
| A Style, 212 Degree | W-12100 |
| B Style, 165 Degree | W-12103 |
| B Style, 212 Degree | W-12104 |
| E Style, 165 Degree | W-12420 |
| E Style, 212 Degree | W-12421 |
| Starlink, 165 Degree | W-12422 |
| Fusible Link Hook | W-12445 |



| Size | Stock# |
|---------------------------|---------|
| RCP-1 Toggle | W-10087 |
| RCP-1K Key | W-10088 |
| RCP-M Momentary | W-12694 |
| RDT-Remote Damper Tester | W-10089 |
| RLP-1 One Light Indicator | W-12688 |
| RLP-2 Two Light Indicator | W-12689 |
| HS-10 Replacement Assy | W-12690 |



FD & FSD LABELS

| Size | Stock# |
|-----------------------------|---------|
| Fire Damper, Single Label | W-12423 |
| Fire Damper, 500 Piece Roll | W-12424 |
| Fire/Smoke, Single Label | W-12425 |
| Fire/Smoke, 500 Piece Roll | W-12426 |



SWITCHES



TESTER



HIGH BLADE BRACKET

| Size | Stock# |
|--|---------|
| 1/2" RD. Damper Drive Arms | W-12428 |
| High Blade Brackets | W-12429 |
| Low Blade Brackets | W-12430 |
| Ball Joint Swivels | W-12432 |
| 1/2" Damper Drive w/ U-clip, 6" | W-12447 |
| 5/16" Brass Trunion | W-12431 |
| 5/16" Steel Rod, Zinc, per foot | W-12427 |
| 1/2" Steel Rod, Zinc, per foot | W-12434 |
| 3/4" Steel Rod, Hollow, Zinc, per foot | W-12437 |
| Damper Blade Jumper Strap | W-12433 |



LOW BLADE BRACKET

5/16" Connecting Rod



DAMPER DRIVE



BALL JOINT SWIVEL



| Size | Stock# |
|---------------------------------------|---------|
| S.S. Steel Oilite Bearing, 1/2" Round | W-12438 |
| Synthetic Bearing, 1/2" Round | W-12439 |
| Synthetic Bearing, 3/8" Square | W-12441 |

BUSHING/BEARINGS



| Size | Stock# |
|--|---------|
| Blade Edge Seal, Bulb, per foot | W-12442 |
| Blade Edge Seal, Closed Cell, per foot | W-12443 |

BLADE EDGE SEAL



MANUAL QUADRANTS

| Size | Stock# |
|---------------------|---------|
| LQ-355, 3/8" Square | W-10092 |
| LQ-560, 1/2" Round | W-10095 |
| LQ-555, 1/2" Square | W-10096 |

ACTUATORS

U.L. FIRE/SMOKE DAMPER ELECTRIC ACTUATORS - 350° DEGREE RATING

BELIMO

5 YEAR WARRANTY



The type FSNF and FSLF spring-return actuators are intended for the operation of smoke and combination fire and smoke dampers in ventilation and air-conditioning systems. The actuator will meet requirements of UL555 and UL555S when tested as an assembly with the damper and will meet requirements of UBC for 15 second opening and closing at 350°F.

Square footage of damper operated will depend on the model required.

FSNF-120

| Catalog# | Model# | Max.Sq.Ft. | Voltage | Power | Aux. Switch | Description |
|----------|------------|------------|---------|-------------|-------------|---------------------------|
| W-11986 | FSLF-120 | 6 | 120 VAC | 11(R), 7(H) | No | 2-Position, Spring Return |
| W-12025 | FSLF-120-S | 6 | 120 VAC | 11(R), 7(H) | Yes | 2-Position, Spring Return |
| W-11991 | FSNF-120 | 16.5 | 120 VAC | 18(R), 6(H) | No | 2-Position, Spring Return |
| W-11993 | FSNF-120-S | 16.5 | 120 VAC | 18(R), 6(H) | Yes | 2-Position, Spring Return |
| W-11992 | FSNF-24 | 16.5 | 24 VAC | 18(R), 6(H) | No | 2-Position, Spring Return |
| W-11987 | FSNF-24-S | 16.5 | 24 VAC | 18(R), 6(H) | Yes | 2-Position, Spring Return |
| W-12031 | FSLF-24 | 6 | 24 VAC | 3(R), 2(H) | No | 2-Position, Spring Return |
| W-12026 | FSLF-24-S | 6 | 24 VAC | 3(R), 2(H) | Yes | 2-Position, Spring Return |
| W-12674 | FSAF-120 | 24 | 120 VAC | 9.5/3.5 | No | 2-Position, Spring Return |
| W-12675 | FSAF-120-S | 24 | 120 VAC | 9.5/3.5 | Yes | 2-Position, Spring Return |
| W-12676 | FSAF-24 | 24 | 24 VAC | 9.5/3.5 | No | 2-Position, Spring Return |
| W-12677 | FSAF-24-S | 24 | 24 VAC | 9.5/3.5 | Yes | 2-Position, Spring Return |

U.L. FIRE/SMOKE DAMPER PNEUMATIC ACTUATORS - 350° DEGREE RATING

SIEMENS



331-4826

The 331-4826 Pneumatic Damper Actuator is a compact, modular, totally enclosed, rolling diaphragm-type actuator designed for modulating or two position actuation. Typical applications are for control and fire/smoke leakage rated dampers or air valves.

The 331-2998 Pneumatic Actuator Damper Actuator is a totally enclosed, pneumatic piston type actuator designed to operate dampers for ventilating systems, mixing box control, and other applications requiring a large effective diaphragm area and long stroke.

SIEMENS



331-2998

| Catalog# | Model# | Max.Sq.Ft. | Pressure | Power | Aux. Switch | Description |
|----------|----------|------------|------------|-----------|-------------|---|
| W-10547 | 331-4826 | 4 | 8 - 13 PSI | Pneumatic | No | The No. 3 Pneumatic Damper Actuator is a Compact, Modular, Totally Enclosed, Rolling Diaphragm-Type Actuator Designed for Modulating or Two Position Actuation. |
| W-10548 | 331-2998 | 12 | 8 -13 PSI | Pneumatic | No | The No. 3 Pneumatic Damper Actuator is a Compact, Modular, Totally Enclosed, Rolling Diaphragm-Type Actuator Designed for Modulating or Two Position Actuation. |

ACTUATORS

ELECTRIC ACTUATORS - 2 POSITION SPRING RETURN - FOR USE WITH AIR CONTROL DAMPERS 5 YEAR WARRANTY

BELIMO



LF



NF/AF

| Catalog# | Model# | Max.Sq.Ft. | Voltage | Power | Aux. Switch | Description |
|----------|--------------|-----------------|---------|-----------------|-------------|---------------------------|
| W-10554 | AF-120-US | 80/40 (w/seals) | 120 | 6(R), 2.3(H) | No | 2-Position, Spring Return |
| W-12002 | AF-120-S-US | 80/40 (w/seals) | 120 | 6(R), 2.3(H) | Yes | 2-Position, Spring Return |
| W-10555 | AF-24-US | 80/40 (w/seals) | 24 | 5(R), 1.5(H) | No | 2-Position, Spring Return |
| W-12005 | AF-24-S-US | 80/40 (w/seals) | 24 | 5(R), 1.5(H) | Yes | 2-Position, Spring Return |
| W-10550 | LF-120-US | 20/10 (w/seals) | 120 | 5.5 (R), 3.5(H) | No | 2-Position, Spring Return |
| W-12000 | LF-120-S-US | 20/10 (w/seals) | 120 | 5.5(R), 3.5(H) | Yes | 2-Position, Spring Return |
| W-10551 | LF-24-US | 20/10 (w/seals) | 24 | 5(R), 2.5(H) | No | 2-Position, Spring Return |
| W-12003 | LF-24-S-US | 20/10 (w/seals) | 24 | 5(R), 2.5(H) | Yes | 2-Position, Spring Return |
| W-10552 | NFUBP-120-US | 40/20 (w/seals) | 120 | 6(R), 3.5(H) | No | 2-Position, Spring Return |
| W-12001 | NFUB-120-S | 40/20 (w/seals) | 120 | 6(R) 3.5(H) | Yes | 2-Position, Spring Return |
| W-10553 | NFB-24 | 40/20 (w/seals) | 24 | 5(R), 2.6(H) | No | 2-Position, Spring Return |
| W-12004 | NFB-24-S | 40/20 (w/seals) | 24 | 5(R), 2.6(H) | Yes | 2-Position, Spring Return |
| W-12449 | TF-120-US | 10/5 (w/seals) | 120 | 2(R), 1.3(H) | No | 2-Position, Spring Return |
| W-12451 | TF-120-S-US | 10/5 (w/seals) | 120 | 2(R), 1.3(H) | Yes | 2-Position, Spring Return |
| W-12450 | TF-24-US | 10/5 (w/seals) | 24 | 2(R), 1.3(H) | No | 2-Position, Spring Return |
| W-12452 | TF-24-S-US | 10/5 (w/seals) | 24 | 2(R), 1.3(H) | Yes | 2-Position, Spring Return |

ELECTRIC ACTUATORS - PROPORTIONAL SPRING RETURN

5 YEAR WARRANTY

For position control, fail-safe control of dampers in HVAC systems. Control is positional from an auxiliary contact, or a manual switch. These actuators provide true spring return operation for reliable application and positive close off on airtight dampers. The spring return system provides constant torque to the damper with, and without, power applied to the actuator.



NF/AF

| Catalog# | Model# | Max.Sq.Ft. | Voltage | Power | Aux. Switch | Description |
|----------|-----------------|-----------------|------------------|--------------|-------------|----------------------------|
| W-12454 | AFX-24-MFT-US | 80/40 (w/seals) | 24 vac (2-10vdc) | 6(R), 1.8(H) | No | Proportional Spring Return |
| W-10557 | AFX-24-MFT-S-US | 80/40 (w/seals) | 24vac (2-10vdc) | 6(R), 1.8(H) | Yes | Proportional Spring Return |
| W-12453 | NFB-24-SR-US | 40/20 (w/seals) | 24vac (2-10vdc) | 3(R),1(H) | No | Proportional Spring Return |
| W-10556 | NFB-24-SR-S-US | 40/20 (w/seals) | 24vac (2-10vdc) | 3(R),1(H) | Yes | Proportional Spring Return |

ELECTRIC ACTUATORS-PROPORTIONAL NON SPRING RETURN

5 YEAR WARRANTY

2-10 VDC OR 4-20 mA CONTROL SIGNAL



LM



AM

| Catalog# | Model# | Max.Sq.Ft. | Voltage | Power | Aux. Switch | Description |
|----------|-----------|-----------------|----------------|----------------|-------------|--|
| W-10560 | AMX24-MFT | 40/30 (w/seals) | 24vac(2-10vdc) | 4(R), 1.25(H) | No | Proportional, Programming Available |
| W-12459 | AMB24-SR | 40/30 (w/seals) | 24vac(2-10vdc) | 4(R), 1.25(H) | Add-On | Proportional |
| W-12460 | AMB24-3 | 40/30 (w/seals) | 24vac | 4(R), 1.25(H) | Add-On | Modulating, Floating Point |
| W-10561 | GMB24-SR | 70/50 (w/seals) | 24vac(2-10vdc) | 4.5(R), 2(H) | Add-On | Proportional |
| W-12461 | GMB24-3 | 70/50 (w/seals) | 24vac | 4.5(R), 2(H) | Add-On | Modulating, Floating Point |
| W-10558 | LMB24-SR | 15/6 (w/seals) | 24vac(2-10vdc) | 1.5(R), 0.5(H) | Add-On | Proportional |
| W-12462 | LMB24-3 | 15/6 (w/seals) | 24vac | 1.5(R), 0.5(H) | Add-On | Modulating, Floating Point |
| W-12463 | LMX24-MFT | 15/6 (w/seals) | 24vac(2-10vdc) | 1.5(R), 0.5(H) | No | Proportional, Programming Available |
| W-12464 | NMB24-3 | 50/25 (w/seals) | 24vac | 2.5(R), 0.5(H) | Add-On | Modulating, Floating Point |
| W-12465 | NMB24-SR | 50/25 (w/seals) | 24vac(2-10vdc) | 2.5(R), 0.5(H) | Add-On | Proportional |

PNEUMATIC ACTUATORS

PROPORTIONAL OR 2 POSITION

KREUTER



MCP-3631

The 331-4826 Pneumatic Damper Actuator is a compact, modular, totally enclosed, rolling diaphragm-type actuator designed for modulating or two position actuation. Typical applications are for control and fire/smoke leakage rated dampers or air valves.

- Fixed or pivot mounting models.
- Position relay available as an option.
- Variety of mounting/linkage kits to fit any application.
- Threaded shaft for easy mounting of accessory items.

SIEMENS



331-4826

| Catalog# | Model# | Spring Range | Description |
|----------|---------------|--------------|---------------------------------------|
| W-51160 | MCP-3631-3000 | 5-10 PSI | Pneumatic, Proportional or 2 Position |
| W-10547 | 331-4826 | 8-13 PSI | Pneumatic, Proportional or 2 Position |
| W-10548 | 331-2998 | 8-13 PSI | Pneumatic, Proportional or 2 Position |



SYSTEM SENSORS

SYSTEM SENSOR D4120 LOW FLOW SMOKE DETECTOR

D4120



- Outside mounting tabs.
- Patented telescoping sampling tube.
- Built-in reset button.
- Interconnectability for multi-fan shutdown (up to fifty air handlers).
- Patented cover tamper trouble signal.
- Easy to clean.
- 24 VAC/DC or 120/VAC operation.
- High-Low voltage barrier.
- UL 268A listed.
- 1 year warranty

| Catalog# | Model# | Description |
|----------|---------|------------------------|
| W-12660 | D4120 | Smoke Detector |
| W-12661 | DST 1.5 | 1.5 Foot Sampling Tube |
| W-12662 | DST 3 | 3 Foot Sampling Tube |
| W-12663 | DST 5 | 5 Foot Sampling Tube |
| W-12664 | DST-10 | 10 Foot Sampling Tube |

SAMPLING TUBE FOR ABOVE DETECTOR



SYSTEM SENSOR 2151 LOW VELOCITY PHOTOELECTRIC (NO FLOW/LOW FLOW) DUCT DETECTOR

2151



- Low profile smoke detector design.
- Low standby current.
- Two LED's "blink" in stand by.
- Detector head plugs easily into base.
- Built-in test switch.
- Built-in tamper-resistant feature.
- Air velocity rating 0 to 3000 FPM.
- 120VAC base with built-in shorting spring.
- Designed for mounting on standard electrical box.
- SEM screws for easy wiring and positive wire retention.
- Removable cover and insect screen for field cleaning.
- UL 268A listed.

Catalog#
W-10564

SMOKE DETECTOR BASE UNIT

B114LP

- 120 VAC base unit for use with 2151 above.

B114LPBT

- 24 VAC/DC base unit for use with 2151 above.



| Model# | Catalog# |
|----------|----------|
| B114LP | W-10565 |
| B114LPBT | W-12652 |

SYSTEM SENSOR CARBON MONOXIDE DETECTOR

- UL 2075
- 12/24 VDC
- Wall or ceiling mounted.
- Code required trouble relay.
- Electro Chemical sensing.



CO1224

Catalog#
W-12478

Accessory Reference



Required to be used with 2151 detector for in-duct installations. Also works with D4120.

RTS451 Remote Test Station

Catalog#
W-12476

EXTERIOR ACCESS PANEL: MODEL XPA



XPA

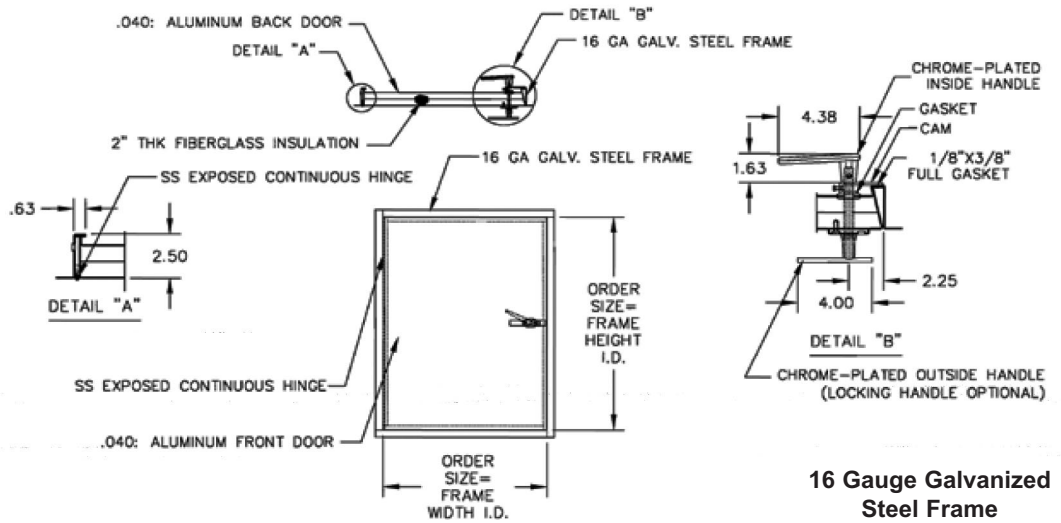

16 Gauge Galvanized Steel Frame

Stainless Steel is also available - Call for Pricing

SPECIFICATIONS: MODEL XPA

- Door: 2" Thick Insulated .040 Aluminum Door.
- Flange: 1" - 16 Ga. Galvanized Steel.
- Exterior Hinge: Stainless Steel.
- Gasketing: EPDM Foam Rubber Bulb Seal.
- Handles: Locking and Non-Locking, Zinc Die Cast with Chrome Plating.
- Handles are factory installed. Panels Are Ready For Installation.
- Finish: Powder Coat Gray Primer.

| Catalog# | Size | Wall Opening | No. Handles |
|----------|---------|-----------------|-------------|
| W-12479 | 12"x12" | 12-3/8"x12-3/8" | 1 |
| W-12480 | 14"x14" | 14-3/8"x14-3/8" | 1 |
| W-12481 | 18"x18" | 18-3/8"x18-3/8" | 1 |
| W-12482 | 24"x24" | 24-3/8"x24-3/8" | 2 |
| W-12483 | 24"x36" | 24-3/8"x36-3/8" | 2 |
| W-12484 | 24"x48" | 24-3/8"x48-3/8" | 2 |
| W-12485 | 30"x30" | 30-3/8"x30-3/8" | 2 |
| W-12486 | 36"x48" | 36-3/8"x48-3/8" | 2 |

*For key lock on above doors add \$25.00 list.

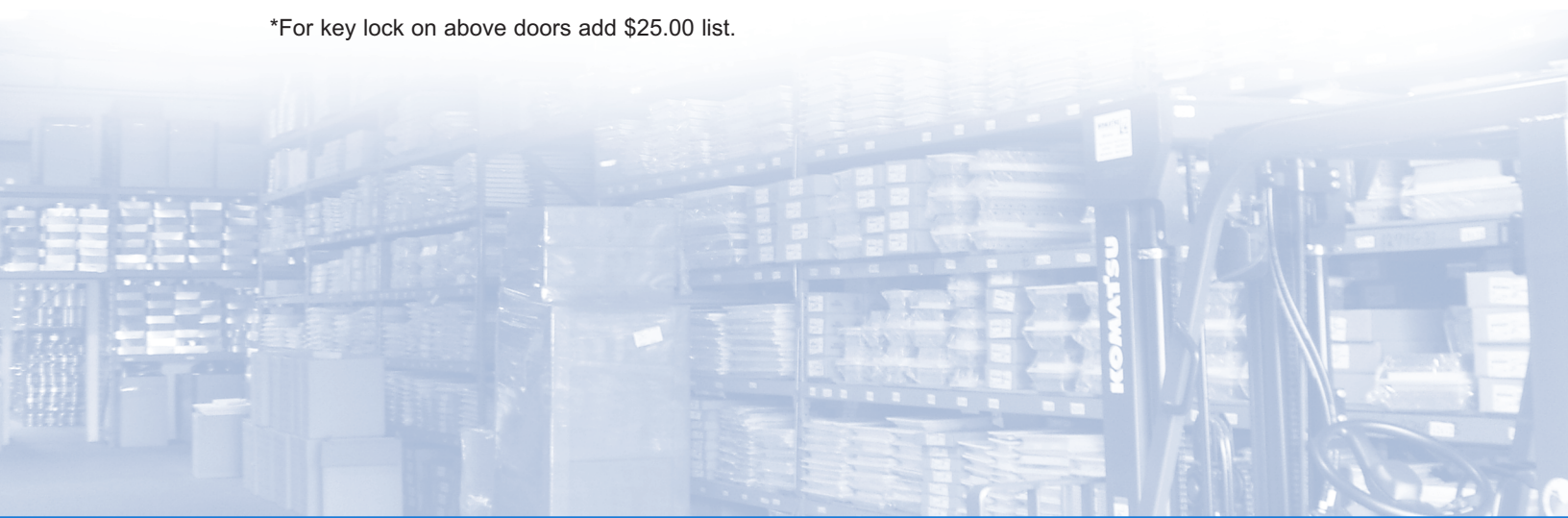

STOCK DRYWALL ACCESS DOORS

TM - GENERAL PURPOSE INTERIOR ACCESS DOOR



TM

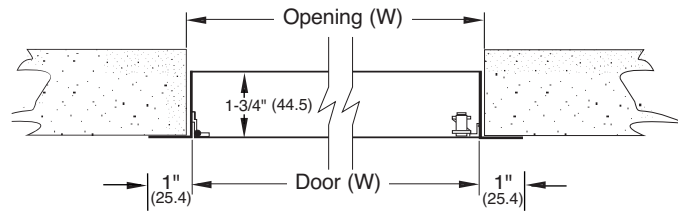

| Catalog# | Size |
|----------|-----------|
| W-11493 | 8" X 8" |
| W-11495 | 10" X 10" |
| W-11496 | 12" X 12" |
| W-11500 | 14" X 14" |
| W-11501 | 16" X 16" |
| W-11503 | 18" X 18" |
| W-11506 | 24" X 24" |
| W-11507 | 24" X 36" |

- For Masonry, tile, and wallboard.
- 16 gauge door and frame.
- Screwdriver operated cam locks.
- Steel construction.
- Phosphate dipped with gray prime coat.
- Concealed hinge on long dimension.
- Cut opening 3/8" larger than nominal.
- Custom sizes and colors also available - Just Ask Us!!!
- Can be ordered with Keylock option.*

* Add \$20.00 list to above doors for key option.

FD - FIRE RATED ACCESS DOOR



FD

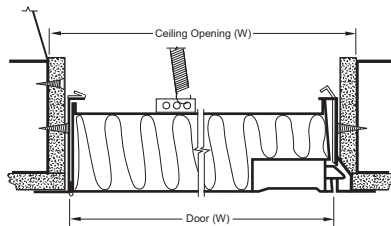

Typical Ceiling Installation

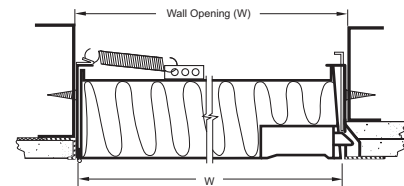

Typical Wall Installation

| Catalog# | Size |
|----------|-----------|
| W-11455 | 8" X 8" |
| W-11456 | 10" X 10" |
| W-11457 | 12" X 12" |
| W-11458 | 14" X 14" |
| W-11459 | 16" X 16" |
| W-11460 | 18" X 18" |
| W-11461 | 20" X 30" |
| W-11462 | 22" X 30" |
| W-11463 | 24" X 24" |
| W-11464 | 24" X 36" |
| W-11465 | 24" X 48" |
| W-11466 | 30" X 30" |
| W-11467 | 32" X 32" |
| W-11468 | 36" X 36" |
| W-11469 | 36" X 48" |

- 1 or 3 Hour UL "B" Label wall rating.
- Warnock Hersey 1 or 3 hour floor/ceiling rating.
- 2" thick, 20 gauge door, 16 gauge frame.
- Self closing, spring-assisted.
- Stocked with flush key hole. Recessed Universal latch for turning and key lock included.
- Concealed hinge on long dimension.
- Phosphate dipped with gray prime coat.
- Cut opening 3/8" larger for walls.
- Frame opening 1-5/8" larger for ceilings and line opening with 5/8" "X" gypsum board.
- Custom sizes and colors also available - Just Ask Us!!!

DUCT ACCESS DOORS

DRUGA - HIGH PRESSURE - ROUND DUCT ACCESS DOOR - UNINSULATED



DRUGA

The DRUGA high pressure round access door is constructed of a stamped galvanized steel panel and features a neoprene gasket.

- Tested to 20" pos. wg & 10" neg. wg pressure.
- Plastic knobs with brass inserts.
- Cut out template for door provided.
- Uninsulated.

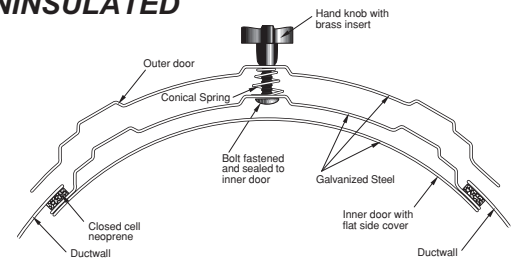

| Catalog# | Model | Duct Size |
|----------|-------------|-----------|
| W-11546 | DRU846GA | 5" - 6" |
| W-11547 | DRU849GA | 7" - 9" |
| W-11548 | DRU8411GA | 10" - 11" |
| W-11549 | DRU12811GA | 10" - 11" |
| W-11551 | DRU12814GA | 12" - 14" |
| W-11552 | DRU12816GA | 15" - 16" |
| W-11553 | DRU161216GA | 15" - 16" |
| W-11554 | DRU161218GA | 17" - 18" |
| W-11555 | DRU161220GA | 19" - 20" |
| W-11556 | DRU161222GA | 21" - 22" |
| W-11557 | DRU161224GA | 23" - 24" |
| W-11558 | DRU161228GA | 25" - 28" |

DUGA - HIGH PRESSURE - SANDWICH DOOR FOR RECTANGULAR DUCT - UNINSULATED

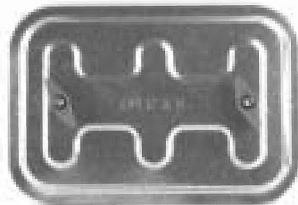

DUGA

The DUGA high pressure sandwich door is constructed of a stamped galvanized steel panel and features a neoprene gasket.

- Tested to 20" pos. wg & 10" neg. wg pressure.
- Plastic knobs with brass inserts.
- Cut out template for door provided.
- Uninsulated.

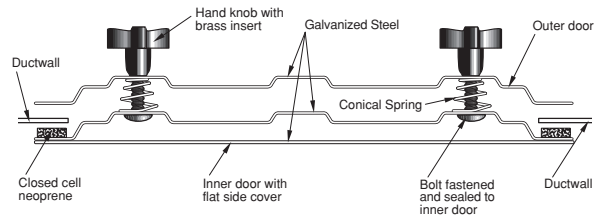

| Catalog# | Model | Duct Size |
|----------|----------|-----------|
| W-11542 | DU106GA | 10"X6" |
| W-11543 | DU128GA | 12"X8" |
| W-11544 | DU1814GA | 18"X14" |
| W-51726 | DU2418GA | 24"X18" |

DC - CIRCULAR CLEAN-OUT DOORS



DCGA

The DC circular clean-out door is airtight and has no frame to install and seal.

- Circular opening effective for duct cleaning.
- Effortless opening and closing.

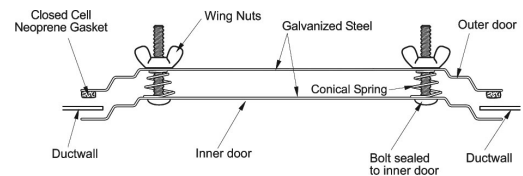

| Catalog# | Model | Duct Size |
|----------|--------|--------------|
| W-11559 | DC8GA | 8" Diameter |
| W-11560 | DC10GA | 10" Diameter |
| W-12371 | DC12GA | 12" Diameter |

DUCT ACCESS DOORS

DF2GA - HIGH TEMPERATURE GREASE DOORS FOR GREASE DUCT, 2300°F

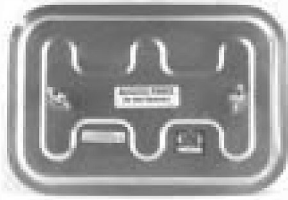

DF2GA

- Cut out template provided.
- Ceramic fiber gasket (2300°F, meets NFPA 96 standards).
- 16 ga. black iron backing plate for grease applications.

The DF2GA is constructed of stamped sealed panels and features steel wing nuts. An excellent clean-out door.

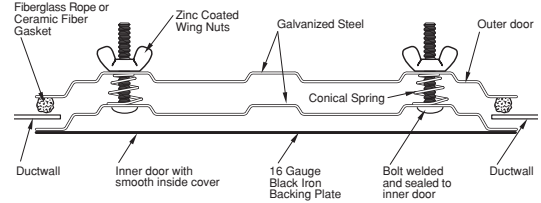

| Catalog# | Model | Duct Size |
|----------|-----------|-----------|
| W-11561 | D106F2GA | 10" X 6" |
| W-11562 | D128F2GA | 12" X 8" |
| W-11563 | D1814F2GA | 18" X 14" |
| W-12339 | D2418F2GA | 24" X 18" |

HAD - HINGED INSULATED DUCT ACCESS DOORS

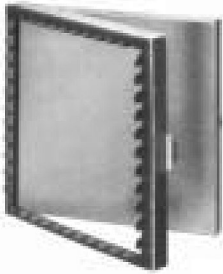

HAD

- High density closed cell gasketing - door to frame & frame to duct.
- Zinc plated continuous steel hinge.
- Thumb-operated steel cam latch(es).
- Hole size is 1" smaller than nominal.

The HAD Hinged Insulated Access Door features galvanized steel construction and 1" high density fiberglass insulation.

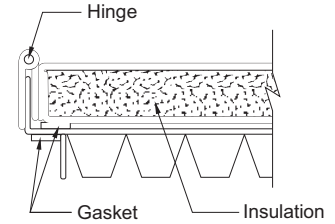

| Catalog# | Size |
|----------|-----------|
| W-11523 | 6" X 6" |
| W-11524 | 8" X 8" |
| W-11525 | 10" X 10" |
| W-11526 | 12" X 12" |
| W-11527 | 14" X 14" |
| W-11528 | 16" X 16" |
| W-11529 | 18" X 18" |
| W-11530 | 20" X 20" |
| W-11531 | 24" X 24" |

CAD - CAMMED DUCT ACCESS DOOR, INSULATED



CAD

- High density closed cell gasketing - door to frame & frame to duct.
- Thumb-operated steel cam latch(es).
- Hole size is 1" smaller than nominal.

The CAD Duct Access Door features galvanized steel construction and 1" high density fiberglass insulation.

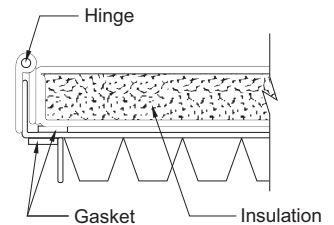

| Catalog# | Size |
|----------|-----------|
| W-12396 | 6" X 6" |
| W-12397 | 8" X 8" |
| W-12398 | 10" X 10" |
| W-12399 | 12" X 12" |
| W-12400 | 14" X 14" |
| W-12401 | 16" X 16" |
| W-12402 | 18" X 18" |
| W-12403 | 20" X 20" |
| W-12404 | 24" X 24" |

DUCT ACCESS DOORS

HAD-P - HINGED INSULATED DUCT ACCESS DOORS - PRESS-ON FLANGED FRAME

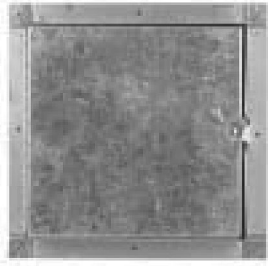

HAD-P

- Double sided adhesive neoprene gasket - for easy installation.
- Zinc plated continuous steel hinge.
- Thumb-operated steel cam latch(es).
- Punched hole start for easy screw flange installation.

The HAD-P Hinged Insulated Duct Access Door features galvanized steel construction and high density closed cell gasketing from the door to the frame only. Features 1" high density fiberglass insulation.

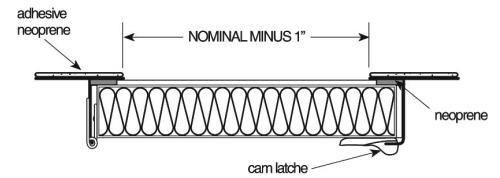

| Catalog# | Size |
|----------|---------|
| W-11532 | 6"X6" |
| W-11533 | 8"X8" |
| W-11534 | 10"X10" |
| W-11535 | 12"X12" |
| W-11536 | 14"X14" |
| W-11537 | 16"X16" |
| W-11538 | 18"X18" |
| W-11539 | 20"X20" |
| W-11540 | 24"X24" |

WAD - WALK-IN INSULATED ACCESS DOOR



WAD

- 1" fiberglass insulation.
- Full length zinc plated continuous vertical hinge.
- Two Ventlock 202 door latches with interior and exterior handles.
- Hole size is nominal.

The WAD Walk-In Insulated Access Door features a 16 gauge galvanized steel frame and 22 gauge galvanized steel double-wall door.

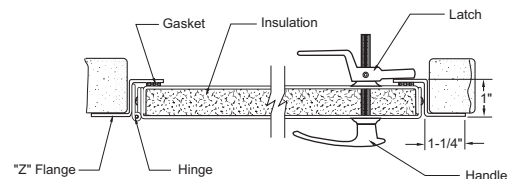

| Catalog# | Size |
|----------|-----------|
| W-11486 | 18" X 36" |
| W-11487 | 18" X 48" |
| W-11489 | 24" X 36" |
| W-11490 | 24" X 48" |
| W-11491 | 24" X 60" |
| W-12509 | 24" X 66" |
| W-11492 | 24" X 72" |

SINGLE DUCT TERMINAL UNITS*

* We can strap two boxes together to make a dual box.

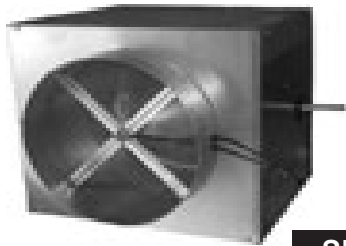

SDV

- ARI Certified sound performance.
- Heavy gauge steel construction.
- Low leakage damper design.
- Thermally insulated inlet tube.
- Acoustically and thermally insulated casing meets UL181 and NFPA 90A requirements.
- Slip and drive discharge connection.
- Damper position indicator mark.
- Electronic controls available.
- Patented Flo-Cross Multipoint Flo-Sensor.
- Also stocked with Insul-Guard (13/16" Rigid Duct Board) lining

Pricing on next page

Model SDV Pneumatic Controls

- Pressure independent.
- Pneumatic actuator.
- Control enclosure optional.
- Damper position indicator on shaft.
- Multifunction controller.
- DA-NO/NC or RA-NO/NC.
- Field calibration required.

Model SDV No Controls

- Unit stocked less controls.
- Control enclosure optional.
- Flo-Cross Multipoint Flo-Sensor.
- 3/8" bare damper shaft.

SDV Dimensional Data

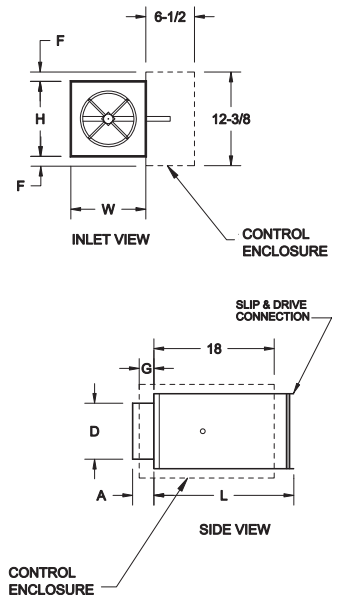

| Unit Size | CFM Range Min to Max | Length (L) | Height (H) | Width (W) | Inlet Dimension (D) |
|-----------|----------------------|------------|------------|-----------|---------------------|
| 6 | 0/100-520 | 15-1/2" | 8" | 12" | 5-7/8" |
| 8 | 0/185-925 | 15-1/2" | 10" | 12" | 7-7/8" |
| 10 | 0/290-1450 | 15-1/2" | 12-1/2" | 14" | 9-7/8" |
| 12 | 0/420-2100 | 15-1/2" | 15" | 16" | 11-7/8" |
| 14 | 0/580-2600 | 15-1/2" | 17-1/2" | 20" | 13-7/8" |
| 16 | 0/740-3700 | 15-1/2" | 18" | 24" | 15-7/8" |
| 24 | 0/1420-7100 | 15" | see above | see above | see above |

SINGLE DUCT TERMINAL UNITS

SINGLE DUCT TERMINAL UNITS, NO CONTROLS

| Catalog# | Size |
|----------|---------|
| W-12341 | 6" |
| W-12342 | 8" |
| W-12343 | 10" |
| W-12344 | 12" |
| W-12345 | 14" |
| W-12346 | 16" |
| W-12510 | 24"X16" |

SINGLE DUCT TERMINAL UNITS, PNEUMATIC CONTROLS

| Catalog# | Size |
|----------|---------|
| W-12347 | 6" |
| W-12348 | 8" |
| W-12349 | 10" |
| W-12350 | 12" |
| W-12351 | 14" |
| W-12352 | 16" |
| W-12511 | 24"X16" |

SINGLE DUCT TERMINAL UNITS, W/ENVIROSEAL LINING, NO CONTROLS

| Catalog# | Size |
|----------|---------|
| W-12521 | 6" |
| W-12522 | 8" |
| W-12523 | 10" |
| W-12524 | 12" |
| W-12525 | 14" |
| W-12526 | 16" |
| W-12527 | 24"X16" |

OPTIONAL HOT WATER COILS 1 ROW AND 2 ROW

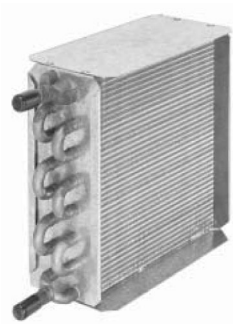

- Copper tubing-aluminum fins.
- Housed in galvanized casing.
- Coil mounts at discharge outlet.
- Slip and drive duct connection.
- Coil ships loose.
- Optional mounting available.

SINGLE DUCT TERMINAL UNITS, W/ENVIROSEAL LINING, PNEUMATIC CONTROLS

| Catalog# | Size |
|----------|-----------|
| W-12528 | 6" |
| W-12529 | 8" |
| W-12530 | 10" |
| W-12531 | 12" |
| W-12532 | 14" |
| W-12533 | 16" |
| W-12534 | 24" x 16" |

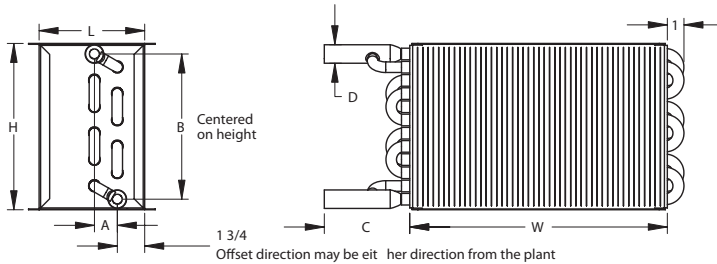

HOT WATER REHEAT COIL, 1-ROW

| Catalog# | Size |
|----------|-----------|
| W-12359 | 6" |
| W-12360 | 8" |
| W-12361 | 10" |
| W-12362 | 12" |
| W-12363 | 14" |
| W-12364 | 16" |
| W-12512 | 24" x 16" |

Offset direction may be either direction from the plant

| Measurements in inches | | | | 1 Row | | | | 2 Row | | | | |
|------------------------|--------|----|-------|-------|--------|-------|-----|-------|-------|--------|-------|-----|
| Size | H | W | L | A | B | C | D | L | A | B | C | D |
| 6 | 8" | 12 | 5 | 0 | 6-1/4 | 3 | 1/2 | 5 | 0 | 6-7/8 | 4-1/4 | 7/8 |
| 8 | 10 | 12 | 5 | 0 | 8-3/4 | 3 | 1/2 | 5 | 1-1/8 | 9 | 4-1/4 | 7/8 |
| 10 | 12-1/2 | 14 | 5 | 1-1/4 | 10-7/8 | 4-1/4 | 7/8 | 5 | 1-1/8 | 11-1/2 | 4-1/4 | 7/8 |
| 12 | 15 | 16 | 5 | 1-1/4 | 13-3/8 | 4-1/4 | 7/8 | 5 | 1-1/8 | 14 | 4-1/4 | 7/8 |
| 14 | 17-1/2 | 20 | 7-1/2 | 1-1/4 | 15-7/8 | 4-1/4 | 7/8 | 7-1/2 | 1-1/8 | 16-1/2 | 4-1/4 | 7/8 |
| 16 | 18 | 24 | 7-1/2 | 1-1/4 | 15-7/8 | 4-1/4 | 7/8 | 7-1/2 | 1-1/8 | 16-1/2 | 4-1/4 | 7/8 |
| 24 | 18 | 38 | 5 | 1-1/4 | 15-7/8 | 4-1/4 | 7/8 | 5 | 1-1/8 | 16-1/2 | 4-1/4 | 7/8 |

HOT WATER REHEAT COIL, 2-ROW

| Catalog# | Size |
|----------|-----------|
| W-12365 | 6" |
| W-12366 | 8" |
| W-12367 | 10" |
| W-12368 | 12" |
| W-12369 | 14" |
| W-12370 | 16" |
| W-12512 | 24" x 16" |

SINGLE DUCT TERMINAL UNIT ACCESSORIES

CONTROL ENCLOSURE



| Catalog# | Size |
|----------|------------------------|
| W-12695 | 18" x 12-3/8" x 6-1/2" |

OPTIONAL STOCK 3 FOOT ATTENUATORS

- 1" insulation, open both ends.
- S and D drive connections.



3-FOOT ATTENUATOR FOR VAV BOXES

| Catalog# | Size |
|----------|-----------|
| W-12514 | 6" |
| W-12515 | 8" |
| W-12516 | 10" |
| W-12517 | 12" |
| W-12518 | 14" |
| W-12519 | 16" |
| W-12520 | 24" x 16" |

SINGLE DUCT AND DUAL DUCT VAV ACCESSORIES

CONTROLS AND ACCESSORIES



| Catalog# | Pneumatic Actuators |
|----------|---|
| W-51160 | MCP-3631-3000, 5-10 psi Pneumatic rotary actuator |
| W-10562 | MCP-3631-5000, 8-13 psi Pneumatic rotary actuator |
| W-12578 | MCP-3631-8000, 3-8 psi Pneumatic rotary actuator |



Transformer and Disconnect

| Catalog# | Size |
|----------|-------------------------|
| W-12584 | Transformer, 120-24 VAC |
| W-12585 | Disconnect, 120-277 VAC |

W-12584



W-12585

LINEAR SLOT DIFFUSERS

LINEAR SLOT DIFFUSERS FROM STOCK OR LOCALLY CUSTOM MADE

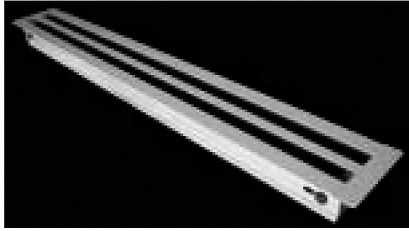

LTSC

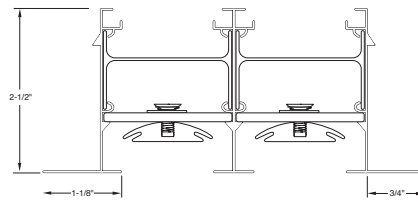

Concealed mounting with hemmed plenum

LTSC Frame

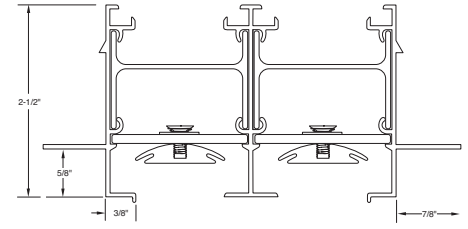

Concealed mounting in hard surfaces

MCS Frame

- Air Managers Linear Slot Diffusers
- Fully adjustable horizontal pattern controller in stock
- 1 slot and 2 slot, 3/4" or 1" slot widths stocked.
- Excellent for VAV applications
- Can be field cut to custom lengths

LINEAR SLOT DIFFUSERS - LTSC FRAME

| Catalog# | Size |
|----------|---------------------|
| W-11176 | 48" x 1 Slot x 3/4" |
| W-11177 | 60" x 1 Slot x 3/4" |
| W-11178 | 72" x 1 Slot x 3/4" |
| W-11182 | 48" x 2 Slot x 3/4" |
| W-11183 | 60" x 2 Slot x 3/4" |
| W-11184 | 72" x 2 Slot x 3/4" |
| W-11173 | 48" x 1 Slot x 1" |
| W-11174 | 60" x 1 Slot x 1" |
| W-11175 | 72" x 1 Slot x 1" |
| W-11179 | 48" x 2 Slot x 1" |
| W-11180 | 60" x 2 Slot x 1" |
| W-11181 | 72" x 2 Slot x 1" |

LINEAR SLOT DIFFUSERS - MCS FRAME

| Catalog# | Size |
|----------|---------------------|
| W-12408 | 48" x 1 Slot x 3/4" |
| W-12409 | 60" x 1 Slot x 3/4" |
| W-12410 | 72" x 1 Slot x 3/4" |
| W-12411 | 48" x 2 Slot x 3/4" |
| W-12412 | 60" x 2 Slot x 3/4" |
| W-12413 | 72" x 2 Slot x 3/4" |
| W-12414 | 48" x 1 Slot x 1" |
| W-12415 | 60" x 1 Slot x 1" |
| W-12416 | 72" x 1 Slot x 1" |
| W-12417 | 48" x 2 Slot x 1" |
| W-12418 | 60" x 2 Slot x 1" |
| W-12419 | 72" x 2 Slot x 1" |

Linear Slot Diffusers feature aluminum construction with end caps or butt caps. They are stocked in a bright white finish with black pattern controller.

MATCHING INSULATED DIFFUSER PLENUMS

- Air Managers insulated linear plenum boot.
- Matching fit for stock linear slot diffusers.
- Galvanized steel construction.
- Stocked in 48", 60" and 72" lengths.

Diffuser Plenums are designed for single diffusers or continuous runs and can be used for supply or return applications. Stocked without inlet collar, must be field cut.



| Catalog# | Size |
|----------|---------------------|
| W-12586 | 48" x 1 Slot x 3/4" |
| W-12587 | 60" x 1 Slot x 3/4" |
| W-12588 | 72" x 1 Slot x 3/4" |
| W-12589 | 48" x 2 Slot x 3/4" |
| W-12590 | 60" x 2 Slot x 3/4" |
| W-12591 | 72" x 2 Slot x 3/4" |
| W-12592 | 48" x 1 Slot x 1" |
| W-12593 | 60" x 1 Slot x 1" |
| W-12594 | 72" x 1 Slot x 1" |
| W-12595 | 48" x 2 Slot x 1" |
| W-12596 | 60" x 2 Slot x 1" |
| W-12597 | 72" x 2 Slot x 1" |

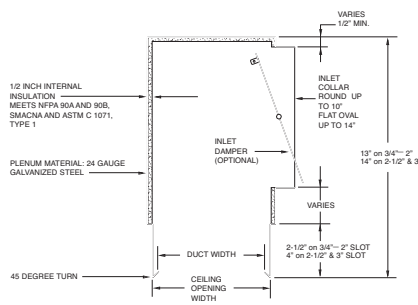

PERFORATED LAY-IN DIFFUSERS

PERFORATED ADJUSTABLE CURVED BLADE LAY-IN T-BAR AND MATCHING RETURN

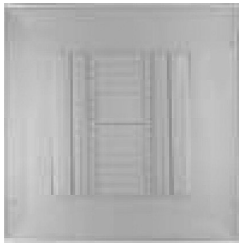

PV

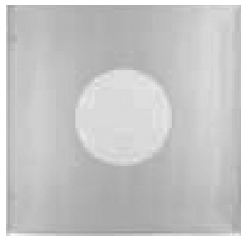

PR

- Tuttle and Bailey curved blade perforated diffuser.
- Round or square neck.
- Unit is standard with adjustable curved blade core in neck.
- Adjustable horizontal to vertical air pattern.
- Diffuser stocked as 4 way blow pattern standard.
- 24" x 24" lay-in ceiling module with removable perforated face.
- White baked enamel finish.



MODEL PV-LT

MODEL PV-NR, Narrow Regress

MODEL PR-LT

MODEL PVR-NR

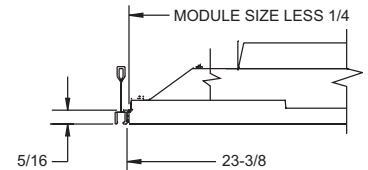
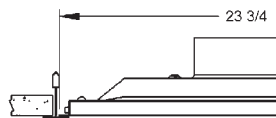
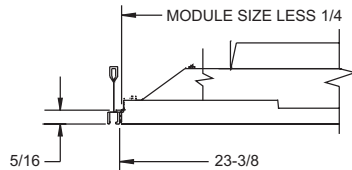
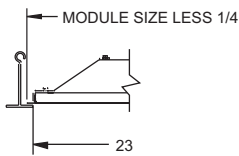

PV-LT, CURVED BLADE, PERFORATED FACE, 24" x 24"--LAY-IN PANEL

PV-NR, CURVED BLADE, PERFORATED FACE, 24" x 24" LAY-IN PANEL, NARROW REGRESS

| Catalog# | Size | Max CFM @ NC |
|----------|---------|--------------|
| W-10213 | 6" | 311@40 |
| W-10214 | 8" | 469@40 |
| W-10215 | 10" | 745@40 |
| W-10216 | 12" | 732@40 |
| W-10217 | 14" | 996@40 |
| W-10218 | 16" | 1094@40 |
| W-10220 | 6"x6" | 314@40 |
| W-10221 | 8"x8" | 473@40 |
| W-10222 | 10"x10" | 639@40 |
| W-10223 | 12"x12" | 840@40 |
| W-10244 | 14"x14" | 1088@40 |
| W-10225 | 16"x16" | 1396@40 |

| Catalog# | Size | Max CFM @ NC |
|----------|---------|--------------|
| W-10317 | 6" | 311@40 |
| W-10318 | 8" | 469@40 |
| W-10319 | 10" | 745@40 |
| W-10320 | 12" | 732@40 |
| W-10321 | 14" | 996@40 |
| W-10322 | 16" | 1094@40 |
| W-10323 | 6"x6" | 314@40 |
| W-10324 | 8"x8" | 473@40 |
| W-10325 | 10"x10" | 639@40 |
| W-10326 | 12"x12" | 840@40 |
| W-10327 | 14"x14" | 1088@40 |
| W-10328 | 16"x16" | 1396@40 |

PR-LT, PERFORATED FACE RETURN, 24" x 24" LAY-IN PANEL

PVR-NR, PERFORATED FACE RETURN, 24" x 24" LAY-IN PANEL, NARROW REGRESS

| Catalog# | Size | Max CFM @ NC |
|----------|---------|--------------|
| W-10234 | 6" | 275@34 |
| W-10235 | 8" | 488@38 |
| W-10236 | 10" | 763@41 |
| W-10237 | 12" | 1099@43 |
| W-10238 | 14" | 1495@46 |
| W-10239 | 16" | 1953@49 |
| W-12294 | 6"x6" | 350@35 |
| W-12295 | 8"x8" | 622@39 |
| W-12296 | 10"x10" | 972@42 |
| W-12297 | 12"x12" | 1400@45 |
| W-12298 | 14"x14" | - |
| W-12299 | 16"x16" | - |
| W-12300 | 18"x18" | 3150@49 |
| W-12302 | 22"x22" | 4706@51 |

| Catalog# | Size |
|----------|---------|
| W-10336 | 6" |
| W-10337 | 8" |
| W-10338 | 10" |
| W-10339 | 12" |
| W-12355 | 14" |
| W-10340 | 16" |
| W-10342 | 6"x6" |
| W-10343 | 8"x8" |
| W-10344 | 10"x10" |
| W-10345 | 12"x12" |
| W-10346 | 14"x14" |
| W-10347 | 16"x16" |

PERFORATED LAY-IN DIFFUSERS

PERFORATED FACE MODULAR CORE LAY-IN T-BAR AND MATCHING RETURN

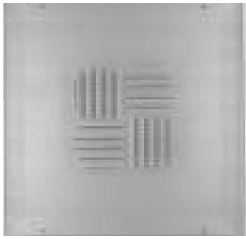

PM

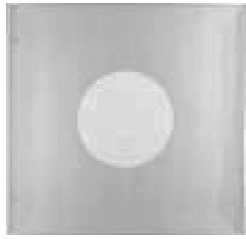

PR

- Tuttle and Bailey modular core perforated diffuser.
- Square neck.
- Removable modular core design.
- Diffuser is adjustable to any blow pattern.
- Diffuser stocked with cores set at 4 way blow standard.
- 24" x 24" lay-in ceiling module with removable perforated face.
- White baked enamel finish.



MODEL PM-LT

MODEL PM-NR, Narrow Regress

MODEL PR-LT

MODEL PVR-NR

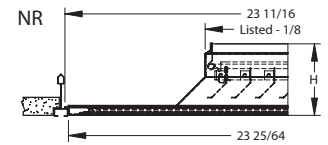
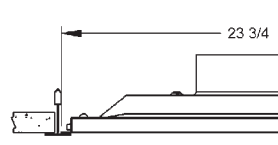
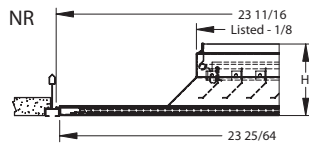
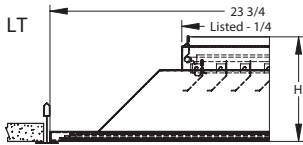

PM-LT, MODULAR CORE, PERFORATED FACE, 24" x 24" LAY-IN PANEL

PM-NR, MODULAR CORE, PERFORATED FACE, 24" x 24" LAY-IN PANEL, NARROW REGRESS

| Catalog# | Size | Max CFM @ NC |
|----------|---------|--------------|
| W-10227 | 6"x6" | 175@22 |
| W-10228 | 8"x8" | 311@27 |
| W-10229 | 10"x10" | 486@31 |
| W-10230 | 12"x12" | 700@35 |
| W-10231 | 14"x14" | - |
| W-10232 | 16"x16" | - |
| W-10233 | 18"x18" | - |

| Catalog# | Size | Max CFM @ NC |
|----------|---------|--------------|
| W-10329 | 6"x6" | 175@22 |
| W-10330 | 8"x8" | 311@27 |
| W-10331 | 10"x10" | 486@31 |
| W-10332 | 12"x12" | 700@35 |
| W-10333 | 14"x14" | - |
| W-10334 | 16"x16" | - |
| W-10335 | 18"x18" | - |

PR-LT, PERFORATED FACE RETURN, 24" x 24" LAY-IN PANEL

PVR-NR, PERFORATED FACE RETURN, 24" x 24" LAY-IN PANEL, NARROW REGRESS

| Catalog# | Size | Max CFM @ NC |
|----------|---------|--------------|
| W-10234 | 6" | 275@34 |
| W-10235 | 8" | 488@38 |
| W-10236 | 10" | 763@41 |
| W-10237 | 12" | 1099@43 |
| W-10238 | 14" | 1495@46 |
| W-10239 | 16" | 1953@49 |
| W-12294 | 6"x6" | 350@35 |
| W-12295 | 8"x8" | 622@39 |
| W-12296 | 10"x10" | 972@42 |
| W-12297 | 12"x12" | 1400@45 |
| W-12298 | 14"x14" | - |
| W-12299 | 16"x16" | - |
| W-12300 | 18"x18" | 3150@49 |
| W-12302 | 22"x22" | 4706@51 |

| Catalog# | Size |
|----------|---------|
| W-10336 | 6" |
| W-10337 | 8" |
| W-10338 | 10" |
| W-10339 | 12" |
| W-12355 | 14" |
| W-10340 | 16" |
| W-10342 | 6"x6" |
| W-10343 | 8"x8" |
| W-10344 | 10"x10" |
| W-10345 | 12"x12" |
| W-10346 | 14"x14" |
| W-10347 | 16"x16" |

PERFORATED LAY-IN DIFFUSERS

PERFORATED FACE MOUNTED ADJUSTABLE AIR PATTERN LAY-IN T-BAR AND MATCHING RETURN

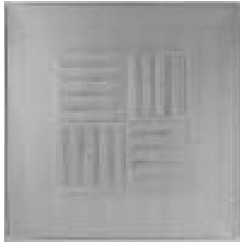

PP

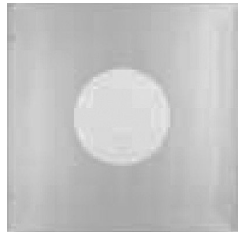

PR

- Tuttle and Bailey economy perforated diffuser.
- Round or square neck.
- Unit is standard with face mounted adjustable air pattern.
- Diffuser is field adjustable to any blow pattern.
- Diffuser stocked with 4 way blow pattern preset.
- 24" x 24" lay-in ceiling module with removable perforated face.
- White baked enamel finish.

MODEL PP-LT

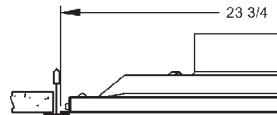

MODEL PR-LT

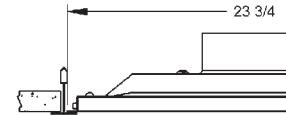

PP-LT, MOUNTED PATTERN DEFLECTORS, PERFORATED FACE, 24" x 24" LAY-IN PANEL

| Catalog# | Size | Max CFM @ NC |
|----------|---------|--------------|
| W-12282 | 6" | 275@43 |
| W-12283 | 8" | 489@49 |
| W-12284 | 10" | 764@54 |
| W-12285 | 12" | 1100@57 |
| W-12286 | 14" | 1497@60 |
| W-12287 | 16" | 1955@63 |
| W-10241 | 6"x6" | 350@45 |
| W-10242 | 8"x8" | 622@51 |
| W-10243 | 10"x10" | 972@56 |
| W-10244 | 12"x12" | 1400@60 |
| W-10245 | 14"x14" | - |
| W-10246 | 16"x16" | - |
| W-10247 | 18"x18" | - |

PR-LT, PERFORATED FACE RETURN, 24" x 24" LAY-IN PANEL

| Catalog# | Size | Max CFM @ NC |
|----------|---------|--------------|
| W-10234 | 6" | 275@34 |
| W-10235 | 8" | 488@38 |
| W-10236 | 10" | 763@41 |
| W-10237 | 12" | 1099@43 |
| W-10238 | 14" | 1495@46 |
| W-10239 | 16" | 1953@49 |
| W-12294 | 6"x6" | 350@35 |
| W-12295 | 8"x8" | 622@39 |
| W-12296 | 10"x10" | 972@42 |
| W-12297 | 12"x12" | 1400@45 |
| W-12298 | 14"x14" | - |
| W-12299 | 16"x16" | - |
| W-12300 | 18"x18" | 3150@49 |
| W-12302 | 22"x22" | 4706@51 |

PERFORATED LAY-IN SCREENS

PERFORATED FACE LAY-IN T-BAR SCREENS

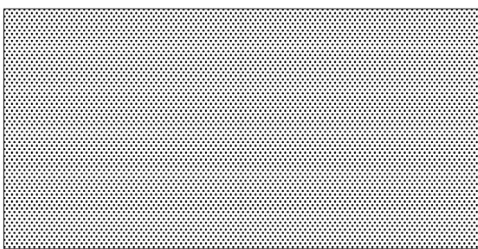

48" x 24"

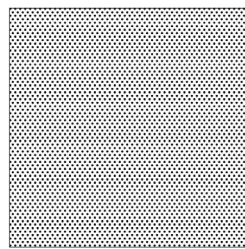

24" x 24"



PTL 24" x 12"

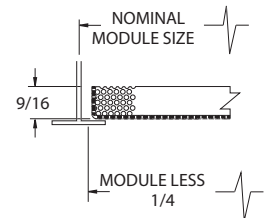

- Steel perforated, non-ducted.
- White baked enamel finish.

PTL-LT, PERFORATED FACE, 24" x 24" LAY-IN PANEL, NON-DUCTED

| Catalog# | Size | Max CFM @ NC |
|----------|---------|--------------|
| W-10963 | 24"x12" | 2548@39 |
| W-10964 | 24"x24" | 5250@42 |
| W-10965 | 48"x24" | - |

PTL-NR, PERFORATED FACE, 24" x 24" LAY-IN PANEL, NON-DUCTED, NARROW REGRESS

| Catalog# | Size |
|----------|---------|
| W-11171 | 24"x24" |

PERFORATED SURFACE MOUNT

PERFORATED FACE SURFACE MOUNT SUPPLY AND RETURN

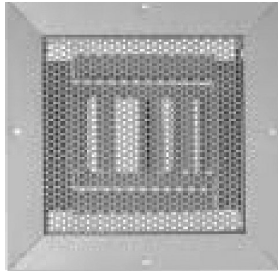

V-PERF-S SUPPLY

- Flat frame construction with screw holes.
- Square neck with removable perforated face.
- Basic curved blade perforated diffuser.
- Diffuser stocked as 4 way blow pattern standard.
- White baked enamel finish.

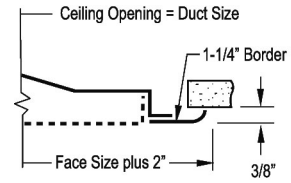

CEILING OPENING IS DUCT SIZE

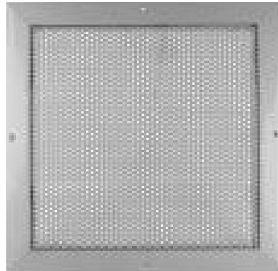

V-PERF-R RETURN

- Flat frame construction with screw holes.
- Square neck with removable perforated face.
- White baked enamel finish.

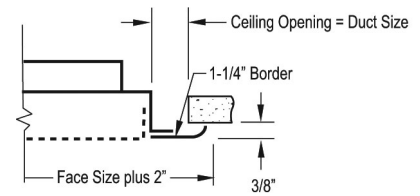

CEILING OPENING IS DUCT SIZE

V-PERF-S, PERFORATED FACE, CURVED BLADE SUPPLY, SURFACE MOUNT

| Catalog# | Size |
|----------|---------|
| W-10886 | 6"x6" |
| W-10887 | 8"x8" |
| W-10888 | 10"x10" |
| W-10889 | 12"x12" |
| W-10890 | 14"x14" |
| W-10891 | 16"x16" |
| W-10892 | 18"x18" |
| W-10893 | 20"x20" |
| W-10894 | 22"x22" |
| W-10895 | 24"x24" |

V-PERF-R, PERFORATED FACE, RETURN, SURFACE MOUNT

| Catalog# | Size |
|----------|---------|
| W-10301 | 6"x6" |
| W-10302 | 8"x8" |
| W-10303 | 10"x10" |
| W-10304 | 12"x12" |
| W-10305 | 14"x14" |
| W-10306 | 16"x16" |
| W-10307 | 18"x18" |
| W-10308 | 20"x20" |
| W-10309 | 22"x22" |
| W-10310 | 24"x24" |

MODULAR CORE DIFFUSERS

MODULAR CORE T-BAR LAY-IN AND SURFACE MOUNT

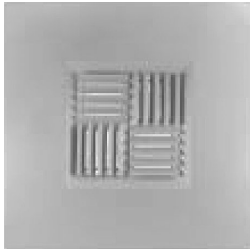

SQD-LT

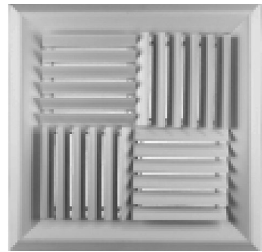

SQD-SB

- Square neck.
- Each individual core can be removed and rotated to provide the required air pattern.
- T-bar lay-in and surface mount units stocked.
- White baked enamel finish.

Note: SOBD's will not fit these diffusers, you must use SMOBD's.

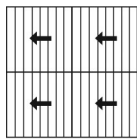
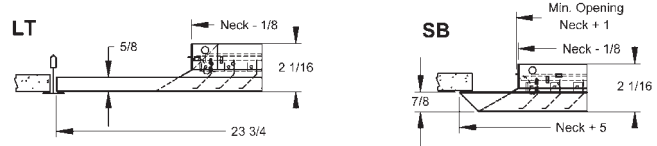

1-Way

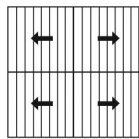

2-Way Opposite

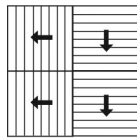

2-Way

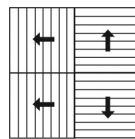

3-Way

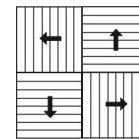

4-Way

SQD-SB, MODULAR CORE, BEVELED FRAME, SURFACE MOUNT

SQD-LT, MODULAR CORE, 24" x 24" LAY-IN PANEL

| Catalog# | Size | Max CFM @ NC |
|----------|---------|--------------|
| W-10131 | 6"x6" | 275@28 |
| W-10132 | 8"x8" | 489@33 |
| W-10133 | 10"x10" | 764@38 |
| W-10134 | 12"x12" | 1100@41 |
| W-10135 | 14"x14" | 1497@44 |
| W-10136 | 16"x16" | 1956@47 |
| W-10137 | 18"x18" | 2475@49 |

| Catalog# | Size | Max CFM @ NC |
|----------|---------|--------------|
| W-10122 | 6"x6" | 275@28 |
| W-10123 | 8"x8" | 489@33 |
| W-10124 | 10"x10" | 764@38 |
| W-10125 | 12"x12" | 1100@41 |
| W-10126 | 14"x14" | 1497@44 |
| W-10127 | 16"x16" | 1956@47 |
| W-10128 | 18"x18" | 2475@49 |
| W-10129 | 20"x20" | 3056@52 |
| W-10130 | 22"x22" | 3697@53 |
| W-12599 | 24"x24" | 4400@55 |

ARCHITECTURAL CEILING PLAQUE DIFFUSER LAY-IN

PLAQUE DIFFUSER T-BAR LAY-IN

Tuttle and Bailey lay-in plaque diffusers feature a round neck connection and a choice of six round neck sizes. The all stamped process means no miter lines or unsightly fasteners.

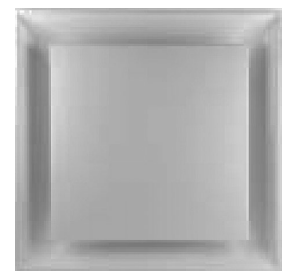
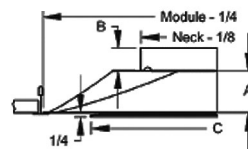

T-1100

T-1100, ARCHITECTURAL PLAQUE DIFFUSER, 24" x 24" LAY-IN PANEL

| Catalog# | Size | Max CFM @ NC |
|----------|------|--------------|
| W-12322 | 6" | 280@34 |
| W-12323 | 8" | 490@38 |
| W-12324 | 10" | 770@41 |
| W-12325 | 12" | 1100@43 |
| W-12326 | 14" | 1500@43 |
| W-12327 | 15" | 1720@46 |

- Diffuser model is 24" square.
- May be used for supply or return.
- 1-1/4" collar for easy duct connection.
- White baked enamel finish.
- Removable plaque face.

LOUVERED FACE CEILING DIFFUSERS - Lay-in and Surface Mount

LOUVERED FACE LAY-IN AND SURFACE MOUNT DIFFUSER

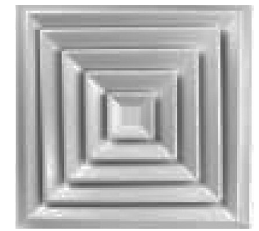
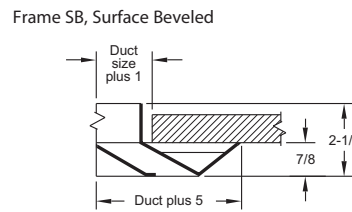
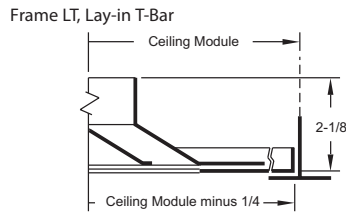

M-LT

- Tuttle and Bailey louvered face diffuser.
- Square neck sizes stocked in 3" increments.
- 4-way fixed air pattern stocked.
- Surface mount ceiling opening is duct plus 1".
- Inner assembly spring loaded and removable.

M-SB

- Excellent for vav and cold air devices.
- White baked enamel finish.
- Removable core.
- Surface mount is beveled frame.

Note: SOBD's will not fit these diffusers, you must use SMOBD's.

M-LT, LOUVERED FACE DIFFUSER, 24" x 24" LAY-IN PANEL

| Catalog# | Size | Max CFM @ NC |
|----------|---------|--------------|
| W-10208 | 6"x6" | 225@34 |
| W-10209 | 9"x9" | 506@37 |
| W-10210 | 12"x12" | 900@37 |
| W-10211 | 15"x15" | 1406@40 |
| W-12600 | 18"x18" | 2025@41 |
| W-12394 | 21"x21" | 2756@42 |

M-SB, LOUVERED FACE DIFFUSER, SURFACE MOUNT, BEVELED FRAME

| Catalog# | Size | Max CFM @ NC |
|----------|---------|--------------|
| W-10201 | 6"x6" | 225@34 |
| W-10202 | 9"x9" | 506@37 |
| W-10203 | 12"x12" | 900@37 |
| W-10204 | 15"x15" | 1406@40 |
| W-10205 | 18"x18" | 2025@41 |
| W-12601 | 21"x21" | 2756@42 |

CURVED BLADE CEILING DIFFUSERS - Surface and Exposed Mount

CURVED BLADE SURFACE MOUNT CEILING DIFFUSERS



- TRU AIRE adjustable curved blade ceiling diffuser.
- Also designed for low sidewall, high sidewall applications.
- White baked enamel finish.
- Curved Blade Surface Mount Ceiling Diffusers feature a 4 way fixed discharge pattern
- Excellent for vav and cold air devices.

| Catalog# | Size |
|----------|---------|
| W-10176 | 6"x6" |
| W-10177 | 8"x8" |
| W-10179 | 10"x10" |
| W-10181 | 12"x12" |
| W-10182 | 14"x14" |
| W-12373 | 16"x16" |
| W-10184 | 18"x18" |

THERMALLY POWERED VAV PLAQUE DIFFUSER

VSD-4, RICKARD THERMALLY POWERED VAV PLAQUE DIFFUSER FOR LAY-IN



VSD-4

- Thermally Actuated using Wax Bulb Technology.
- 10 Yr. Replacement Parts Warranty.
- No Electrical Requirements.
- No Tools Needed to Set Temperature Setpoints.
- Reversing Changeover.
- No Routine Maintenance Required.
- Self Contained • ARI Certified.

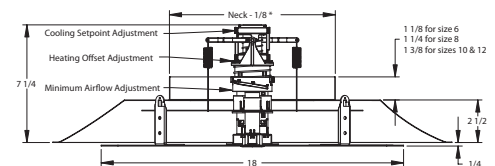
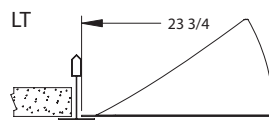

| Catalog# | Size | Max CFM @ NC |
|----------|------|--------------|
| W-12602 | 6" | 196@25 |
| W-12603 | 8" | 349@28 |
| W-12604 | 10" | 545@34 |
| W-12605 | 12" | 785@44 |

ROUND NECK STAMPED LOUVERED DIFFUSER LAY-IN



HIGH VOLUME SQUARE FACE LOUVERED DIFFUSER

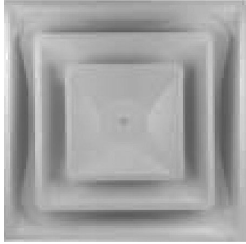

- Excellent performance for both vav and cold air devices.
- Choice of six round neck sizes.
- Diffuser module is 24" square.
- 1-1/4" collar for easy duct connection.
- White baked enamel finish.
- Earthquake tabs standard.

S1200-LT

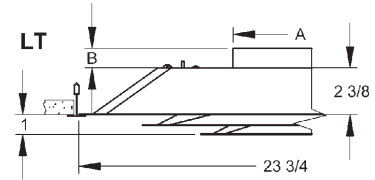

S1200-LT, ROUND NECK 2-CONE LOUVERED FACE DIFFUSER, LAY-IN

Tuttle and Bailey high volume 2 cone louvered face diffuser is constructed with a stamped process which features no miter lines or unsightly fasteners. The anti-streak, anti-smudge design keeps your ceiling clean.

| Catalog# | Size | Max CFM @ NC |
|----------|------|--------------|
| W-10195 | 6" | 216@29 |
| W-10196 | 8" | 384@33 |
| W-10197 | 10" | 600@36 |
| W-10198 | 12" | 864@39 |
| W-10199 | 14" | 1069@38 |
| W-10200 | 15" | 1227@38 |

ROUND FACE FIXED DISCHARGE CONE DIFFUSER

HIGH CAPACITY ROUND FACE DIFFUSER - Exposed or Surface Mount

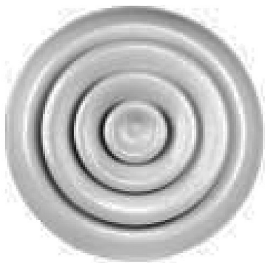

P3

- Tuttle and Bailey round face high capacity diffuser.
- Heavy gauge steel construction.
- Core is easily removed for installation or maintenance.
- Stocked in 2" increments.
- Two horizontal discharge settings.
- Center button is removable for access to damper (not included).
- White baked enamel finish.

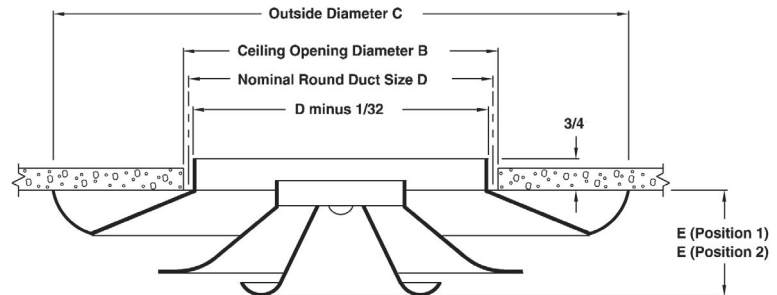

P3, THREE CONE ROUND CEILING DIFFUSER

| Catalog# | Size | Max CFM @ NC POS1.2 |
|----------|------|---------------------|
| W-10187 | 6" | 275@37/42 |
| W-10188 | 8" | 490@39/44 |
| W-10189 | 10" | 763@41/45 |
| W-10190 | 12" | 1100@43/46 |
| W-10191 | 14" | 1490@44/47 |
| W-10192 | 16" | 1960@45/48 |
| W-10193 | 18" | 2480@41/44 |
| W-12606 | 20" | 3060@47/49 |
| W-12650 | 24" | 4400@49/50 |

| Nominal Round Duct Size D | B | C | E (Pos. 1) | E (Pos. 2) |
|---------------------------|--------|--------|------------|------------|
| 06 | 6-1/2 | 11-1/8 | 1-3/4 | 1-1/8 |
| 08 | 8-1/2 | 14-3/4 | 2-1/8 | 1-1/2 |
| 10 | 10-1/2 | 18-1/4 | 2-7/8 | 2-1/8 |
| 12 | 12-1/2 | 22 | 3-1/8 | 2-3/8 |
| 14 | 14-1/2 | 26 | 3-3/8 | 2-5/8 |
| 16 | 16-1/2 | 29 | 4 | 3-1/4 |
| 18 | 18-1/2 | 32-1/2 | 4-3/4 | 3-7/8 |
| 20 | 20-1/2 | 36 | 5-7/8 | 4-7/8 |
| 24 | 24-1/2 | 43-1/4 | 7-3/4 | 6-5/8 |

STATIONARY RETURN GRILLE

STEEL BAR STYLE RETURN GRILLE - EXPOSED OR SIDEWALL SURFACE MOUNT



- Steel fixed horizontal blades on 3/4" centers.
- Steel 1-1/4" flat border frame with screw holes.
- Countersunk screw holes and mounting screws.
- Blades are fixed at 35 degree deflection.

T70D

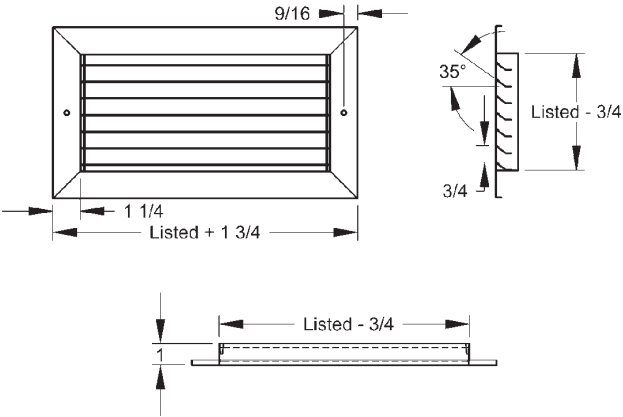

T70D-LT FIXED BAR STYLE RETURN GRILLE, LAY-IN

| Catalog# | Size |
|----------|---------|
| W-10114 | 6"x6" |
| W-10115 | 8"x8" |
| W-10116 | 10"x10" |
| W-10117 | 12"x12" |
| W-10118 | 14"x14" |
| W-10119 | 16"x16" |
| W-10120 | 18"x18" |
| W-10121 | 22"x22" |

T70D FIXED BAR STYLE RETURN GRILLE, SURFACE MOUNT

| Catalog# | Size |
|----------|---------|
| W-10437 | 6"x6" |
| W-10438 | 8"x4" |
| W-10439 | 8"x6" |
| W-10440 | 8"x8" |
| W-10441 | 10"x4" |
| W-10442 | 10"x6" |
| W-10443 | 10"x8" |
| W-10444 | 10"x10" |
| W-10445 | 12"x4" |
| W-10446 | 12"x6" |
| W-10447 | 12"x8" |
| W-10448 | 12"x10" |
| W-10449 | 12"x12" |
| W-10450 | 14"x4" |
| W-10451 | 14"x6" |
| W-10452 | 14"x8" |
| W-10453 | 14"x10" |
| W-10454 | 14"x12" |
| W-10455 | 14"x14" |
| W-10456 | 16"x4" |
| W-10457 | 16"x6" |
| W-10458 | 16"x8" |
| W-10459 | 16"x10" |
| W-10460 | 16"x12" |
| W-10461 | 16"x14" |
| W-10462 | 16x16 |
| W-10463 | 18"x4" |
| W-10464 | 18"x6" |
| W-10465 | 18"x8" |
| W-10466 | 18"x10" |
| W-10467 | 18"x12" |
| W-10468 | 18"x14" |
| W-10469 | 18"x16" |
| W-10470 | 18"x18" |
| W-10471 | 20"x4" |
| W-10472 | 20"x6" |
| W-10473 | 20"x8" |
| W-10474 | 20"x10" |
| W-10475 | 20"x12" |
| W-10476 | 20"x14" |
| W-10477 | 20"x16" |

| Catalog# | Size |
|----------|---------|
| W-10478 | 20"x18" |
| W-10479 | 20"x20" |
| W-12623 | 22"x10" |
| W-10480 | 22"x22" |
| W-10481 | 24"x4" |
| W-10482 | 24"x6" |
| W-10483 | 24"x8" |
| W-10484 | 24"x10" |
| W-10485 | 24"x12" |
| W-10486 | 24"x14" |
| W-10487 | 24"x16" |
| W-10488 | 24"x18" |
| W-10489 | 24"x20" |
| W-10490 | 24"x24" |
| W-10491 | 30"x4" |
| W-10492 | 30"x6" |
| W-10493 | 30"x8" |
| W-10494 | 30"x10" |
| W010495 | 30"x12" |
| W-10496 | 30"x14" |
| W-10497 | 30"x16" |
| W-10498 | 30"x18" |
| W-10499 | 30"x20" |
| W-10500 | 30"x24" |
| W-10501 | 30"x30" |
| W-10502 | 36"x6" |
| W-10503 | 36"x8" |
| W-10504 | 36"x10" |
| W-10505 | 36"x12" |
| W-10506 | 36"x14" |
| W-10507 | 36"x16" |
| W-10508 | 36"x18" |
| W-10509 | 36"x20" |
| W-10510 | 36"x24" |
| W-12624 | 36"x30" |
| W-12625 | 36"x36" |
| W-12626 | 46"x22" |
| W-12627 | 48"x12" |
| W-12628 | 48"x24" |
| W-12629 | 48"x36" |
| W-12630 | 48"x48" |

BAR STYLE FILTER GRILLE

STEEL BAR STYLE FILTER GRILLES FOR T-BAR



- Steel filter frame for 1" filter.
- Hinged parallel to blades.
- Screw driver latches.
- White baked enamel finish.
- Filters not included.

S90H-FF-TB

| Catalog# | Size |
|----------|---------|
| W-10516 | 20"x20" |
| W-12636 | 44"x20" |

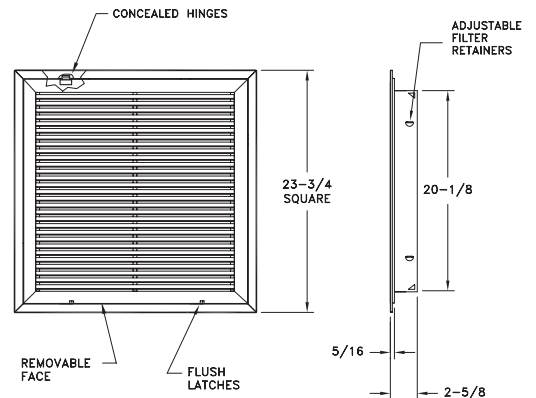

DOUBLE DEFLECTION BAR TYPE SUPPLY REGISTERS

STEEL SUPPLY REGISTER - EXPOSED OR SIDEWALL SURFACE MOUNT

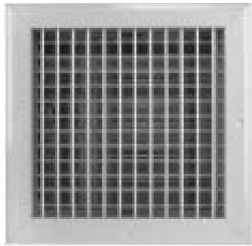

T64

- Steel adjustable vertical face bars and horizontal back bars on 3/4" center.
- 1-1/4" flat border frame with screw holes.
- Countersunk screw holes and mounting screws included.
- Polyurethane foam gasket included on frame.
- Steel OBD damper included.
- White baked enamel finish.

Damper Detail

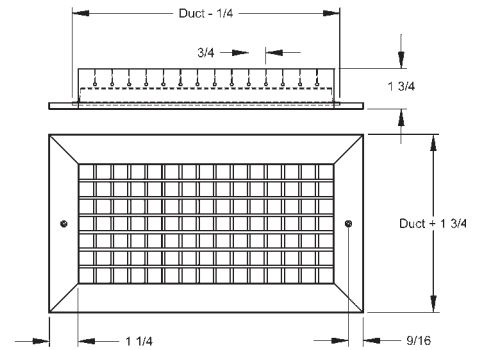
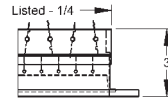

T64, DOUBLE DEFLECTION BAR TYPE SUPPLY REGISTER W/OBD

| Catalog# | Size |
|----------|---------|
| W-10686 | 6"x4" |
| W-10687 | 6"x6" |
| W-10688 | 8"x4" |
| W-10689 | 8"x6" |
| W-10690 | 8"x8" |
| W-10691 | 10"x4" |
| W-10692 | 10"x6" |
| W-10693 | 10"x8" |
| W-10694 | 10"x10" |
| W-10695 | 12"x4" |
| W-10696 | 12"x6" |
| W-10697 | 12"x8" |
| W-10698 | 12"x10" |
| W-10699 | 12"x12" |
| W-10700 | 14"x4" |
| W-10701 | 14"x6" |
| W-10702 | 14"x8" |
| W-10703 | 14"x10" |
| W-10704 | 14"x12" |
| W-10705 | 14"x14" |
| W-10706 | 16"x4" |
| W-10707 | 16"x6" |
| W-10708 | 16"x8" |
| W-10709 | 16"x10" |
| W-10710 | 16"x12" |

| Catalog# | Size |
|----------|---------|
| W-10711 | 16"x14" |
| W-10712 | 16"x16" |
| W-10713 | 18"x4" |
| W-10714 | 18"x6" |
| W-10715 | 18"x8" |
| W-10716 | 18"x10" |
| W-10717 | 18"x12" |
| W-10718 | 18"x14" |
| W-12607 | 18"x16" |
| W-10719 | 18"x18" |
| W-10720 | 20"x4" |
| W-10721 | 20"x6" |
| W-10722 | 20"x8" |
| W-10723 | 20"x10" |
| W-10724 | 20"x12" |
| W-10725 | 20"x14" |
| W-12608 | 20"x16" |
| W-12609 | 20"x20" |
| W-10726 | 24"x4" |
| W-10727 | 24"x6" |
| W-10728 | 24"x8" |
| W-10729 | 24"x10" |
| W-10730 | 24"x12" |
| W-10731 | 24"x14" |
| W-12610 | 24"x16" |

| Catalog# | Size |
|----------|---------|
| W-12611 | 24"x18" |
| W-12612 | 24"x20" |
| W-10732 | 24"x24" |
| W-10733 | 30"x4" |
| W-10734 | 30"x6" |
| W-10735 | 30"x8" |
| W-10736 | 30"x10" |
| W-10737 | 30"x12" |
| W-10738 | 30"x14" |
| W-12613 | 30"x16" |
| W-12614 | 30"x18" |
| W-12615 | 30"x20" |
| W-12616 | 30"x24" |
| W-12617 | 30"x30" |
| W-12313 | 36"x6" |
| W-12314 | 36"x8" |
| W-12308 | 36"x10" |
| W-12309 | 36"x12" |
| W-12310 | 36"x14" |
| W-12618 | 36"x16" |
| W-12619 | 36"x18" |
| W-12620 | 36"x20" |
| W-12621 | 36"x24" |
| W-12622 | 36"x30" |

STEEL AUXILIARY MOUNTING FRAME - Conversion From T-Bar to Surface

MODEL SMF 24" x 24"

- Enables fast and efficient installation of a T-Bar diffuser or grille in a hard or plaster ceiling.
- Easy and simple installation.
- Allows easy access to ceiling plenum space.
- Wide flange provides a clean look.
- White baked enamel finish.
- Mounting hardware included.
- Recommended ceiling opening is module size plus 1/4".

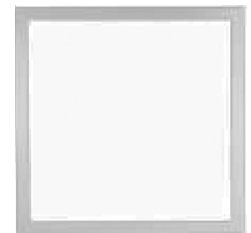
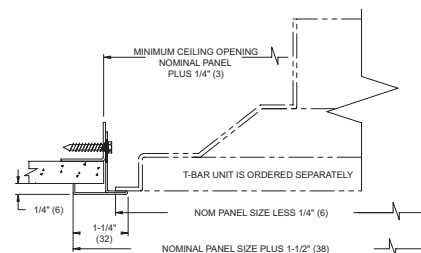

SMF

Catalog#

W-11375

ALUMINUM EGG-CRATE RETURN GRILLE - Lay-In and Surface Mount

MODEL CRE500-LT AND CRE500-SF SURFACE MOUNT

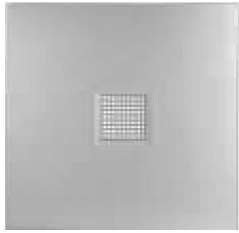

CRE500-LT

- Aluminum cube core 1/2" x 1/2" x 1/2".
- Aluminum 1-1/4" flat frame with screw holes.
- T-bar units stocked with 24" x 24" panels.
- Furnished with countersunk screw holes and mounting screws for surface mount units.
- White baked enamel finish.

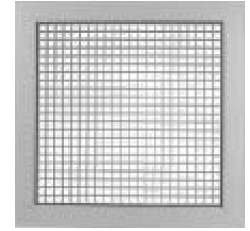

CRE500-SF

CRE500-LT, EGG-CRATE RETURN GRILLE, LAY-IN

| Catalog# | Size |
|----------|---------|
| W-10291 | 6"x6" |
| W-10292 | 8"x8" |
| W-10293 | 10"x10" |
| W-10294 | 12"x12" |
| W-10295 | 14"x14" |
| W-10296 | 16"x16" |
| W-10297 | 18"x18" |
| W-10298 | 20"x20" |
| W-10299 | 22"x22" |
| W-10300 | 46"x22" |

CRE500-SF, EGG-CRATE RETURN GRILLE, SURFACE MOUNT

| Catalog# | Size |
|----------|---------|
| W-10279 | 6"x6" |
| W-10280 | 8"x8" |
| W-10281 | 10"x10" |
| W-10282 | 12"x12" |
| W-10283 | 14"x14" |
| W-10284 | 16"x16" |
| W-10285 | 18"x18" |
| W-10286 | 20"x20" |
| W-10287 | 22"x22" |
| W-10288 | 24"x24" |
| W-10289 | 46"x22" |

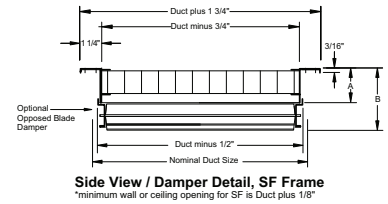
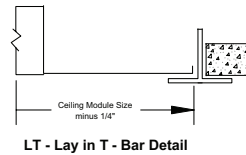

SINGLE DEFLECTION MULTI-SHUTTER SUPPLY REGISTERS

STEEL SUPPLY REGISTER - EXPOSED OR SIDEWALL SURFACE MOUNT

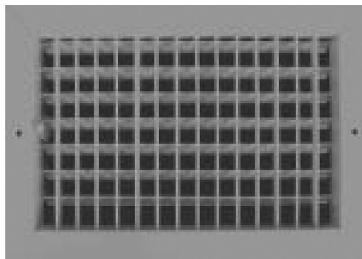

900V

- Steel adjustable vertical face bars.
- Multi-louver damper included.
- White baked enamel finish.

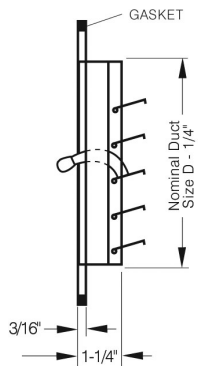

| Catalog# | Size |
|----------|---------|
| W-10746 | 6"x6" |
| W-10747 | 8"x4" |
| W-10748 | 8"x6" |
| W-10749 | 8"x8" |
| W-10750 | 10"x4" |
| W-10751 | 10"x6" |
| W-10752 | 10"x8" |
| W-10753 | 10"x10" |
| W-10754 | 12"x4" |
| W-10755 | 12"x6" |
| W-10756 | 12"x8" |
| W-10757 | 12"x10" |
| W-10758 | 12"x12" |
| W-10759 | 14"x4" |
| W-10760 | 14"x6" |
| W-10761 | 14"x8" |
| W-10762 | 14"x10" |
| W-10763 | 14"x12" |
| W-10764 | 14"x14" |
| W-10765 | 16"x4" |
| W-10766 | 16"x6" |
| W-10767 | 16"x8" |
| W-10768 | 16"x10" |
| W-10769 | 16"x12" |
| W-10770 | 16"x14" |

| Catalog# | Size |
|----------|---------|
| W-10771 | 16"x16" |
| W-10772 | 18"x4" |
| W-10773 | 18"x6" |
| W-10774 | 18"x8" |
| W-10775 | 18"x10" |
| W-10776 | 18"x12" |
| W-10777 | 18"x14" |
| W-10778 | 18"x18" |
| W-10779 | 20"x4" |
| W-10780 | 20"x6" |
| W-10781 | 20"x8" |
| W-10782 | 20"x10" |
| W-10783 | 20"x12" |
| W-10784 | 20"x14" |
| W-10786 | 24"x4" |
| W-10787 | 24"x6" |
| W-10788 | 24"x8" |
| W-10789 | 24"x10" |
| W-10790 | 24"x12" |
| W-10791 | 24"x14" |
| W-12376 | 24"x24" |
| W-12631 | 30"x4" |
| W-12632 | 30"x6" |
| W-12633 | 30"x8" |
| W-12634 | 30"x10" |
| W-12635 | 30"x12" |
| W-12337 | 30"x14" |

DOOR LOUVERS

STEEL FIRE RATED 1900A DOOR LOUVER STEEL NON-RATED 700A DOOR LOUVER



1900A



700A

The 1900A is constructed of 16 gauge steel and the 700A is constructed of 18 gauge steel. Both have a bronze baked enamel finish.

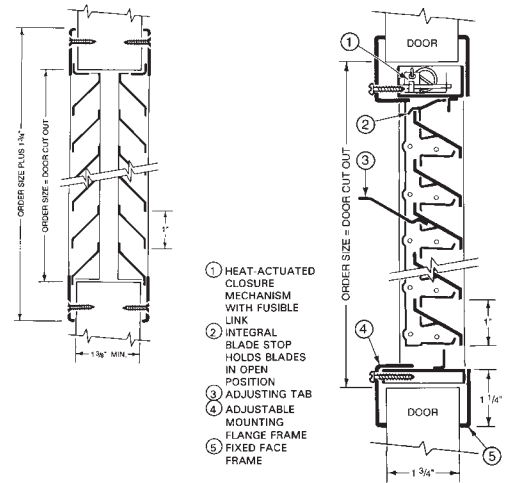

1900A, Steel, Fire-Rated

| Catalog# | Size |
|----------|-------|
| W-11315 | 12x12 |
| W-11316 | 14x14 |
| W-11317 | 16x16 |
| W-11318 | 18x12 |
| W-11319 | 18x18 |
| W-11320 | 24x12 |
| W-11321 | 24x18 |
| W-11322 | 24x24 |

700A, Steel, Non-Rated

| Catalog# | Size |
|----------|-------|
| W-11307 | 12x12 |
| W-11308 | 14x14 |
| W-11309 | 16x16 |
| W-11310 | 18x12 |
| W-11311 | 18x18 |
| W-11312 | 24x12 |
| W-11313 | 24x18 |
| W-11314 | 24x24 |

- #8 x 3/4 Phillips screw fasteners.
- 1900A UL fire rated for use in fire doors with up to a 1-1/2 hour rating
- Free area: 50%-700A, 45%-1900A.

2" DEEP STEEL LOUVER

EXTERIOR 2" DEEP SL245-F BONDERIZED STEEL LOUVER



SL245-F

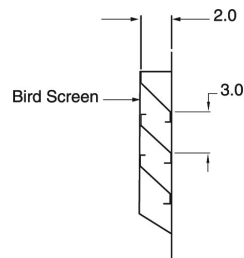

2" Steel louver has a bonderized 26 gauge steel frame and blades with a 45 degree blade profile. It features all spot welded construction.

Steel Louver, Flanged Frame

| Catalog# | Size |
|----------|-------|
| W-12357 | 8x8 |
| W-11323 | 10x10 |
| W-11324 | 12x12 |
| W-11325 | 14x14 |
| W-11326 | 16x16 |
| W-11327 | 18x18 |
| W-11328 | 20x20 |
| W-11329 | 24x24 |

- 45 degree blade profile.
- Slim 2" deep profile.
- 1-1/2" bonderized steel flange standard.
- 1/4" mesh bird screen standard.
- All units supplied 1/4" under nominal size.



ROUND OPPOSED BLADE DAMPER - For Round Neck Applications



RON

- Blades are gang-operated via flat blade screwdriver from below.
- Steel construction.
- Gray baked enamel finish.

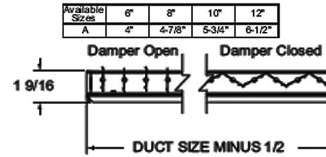
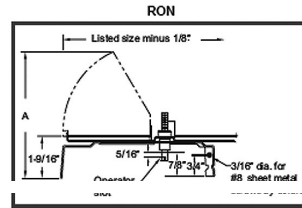

| Catalog# | Size |
|----------|------|
| W-10272 | 6" |
| W-10273 | 8" |
| W-10274 | 10" |
| W-10275 | 12" |

Round Opposed Blade Dampers snap into position in diffusers without requiring the use of tools, for a more efficient installation.

SQUARE OPPOSED BLADE DAMPER - For Square Neck Diffusers and Grilles

MODEL SOBD

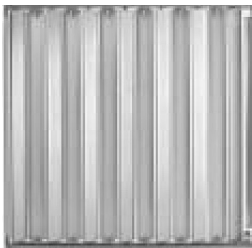

SOBD

- Gang-operated blades.
- Damper operates with medium size flat blade screwdriver.
- Electrogalvanized steel construction.
- Tools-free mounting
- Includes mounting pins. Pins install by finger pressure.

| Catalog# | Size |
|----------|---------|
| W-10252 | 6"x6" |
| W-10254 | 8"x8" |
| W-10258 | 10"x10" |
| W-10260 | 12"x12" |
| W-10263 | 14"x14" |
| W-10265 | 16"x16" |
| W-10266 | 18"x18" |
| W-10268 | 20"x20" |
| W-10270 | 22"x22" |
| W-10271 | 24"x24" |

MODEL SMOBD - For use with SQD, M, PR & PV Series



SMOBD

- Gang-operated blades.
- Damper operates with medium size flat blade screwdriver.
- Electrogalvanized steel construction.
- Tools-free mounting
- Includes mounting pins. Pins install by finger pressure.

| Catalog# | Size |
|----------|-----------|
| W-12654 | 6" x 6" |
| W-12665 | 8" x 8" |
| W-12655 | 9" x 9" |
| W-12666 | 10" x 10" |
| W-12656 | 12" x 12" |
| W-12667 | 14" x 14" |
| W-12657 | 15" x 15" |
| W-12668 | 16" x 16" |
| W-12658 | 18" x 18" |
| W-12669 | 20" x 20" |
| W-12659 | 21" x 21" |
| W-12670 | 22" x 22" |
| W-12671 | 24" x 24" |

ROUND NECK OPPOSED BLADE DAMPER

MODEL ROD



ROD

- Blades are gang-operated for quick adjustment.
- Adjustment is via flat-blade screwdriver from below the face of the diffuser.
- Duct mounted, not recommended for use in flexible ducts.

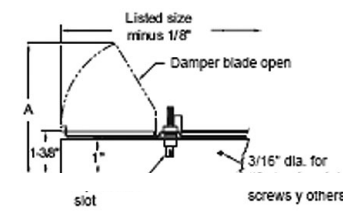

| Available Sizes | 6" | 8" | 10" | 12" |
|-----------------|--------|--------|-----|--------|
| A | 4-1/4" | 5-1/8" | 6" | 6-7/8" |

| Catalog# | Size |
|----------|------|
| W-12637 | 6" |
| W-12638 | 8" |
| W-12639 | 10" |
| W-12640 | 12" |
| W-12641 | 14" |
| W-12642 | 16" |
| W-12643 | 18" |
| W-12644 | 20" |
| W-12645 | 24" |

Standard finish is 6"-12" Mill
or 14"-24" Black enamel

AIR TECH SALES

Manufacturer's Representative for the HVAC Industry Since 1977

SALAD COSMOS, DIXON, CA



PANA PACIFIC, FRESNO, CA



DUBLIN HIGH SCHOOL, DUBLIN, CA



CLOVIS WEST HIGH SCHOOL, CLOVIS, CA



1830 Vernon Street Suite 2
Roseville, CA 95678

Phone: (916)969-6730
Fax: (916)782-7550

www.airtechsales.com